

MOTOR		
Hersteller / Modell	Cummins QSB6.7	
Typ	Wassergekühlter, 4-takt Dieselmotor, 6 Zylinder in Reihe, Direkteinspritzer mit Turbolader, Laderluftkühlung und niedriger Emission	
Nennleistung am Schwungrad	SAE J1995 (brutto)	117 kW (157 PS) bei 2150 U/min
	SAE J1349 (netto)	111 kW (149 PS) bei 2150 U/min
	DIN 6271/1 (brutto)	117 kW (159 PS) bei 2150 U/min
	DIN 6271/1 (netto)	111 kW (151 PS) bei 2150 U/min
Höchst Drehmoment	68.6 kgf·m (496 lbf·ft) bei 1500 U/min	
Bohrung x Hub	107 x 124 mm (4.21" x 4.88")	
Hubraum	6700 cc (409 cu in)	
Batterien	2 x 12 V x 100 Ah	
Anlasser	24 V - 4.8 kW	
Generator	24 V - 95 A	

HYDRAULIKSYSTEM	
HAUPTPUMPE	
Typ	Verstellbare Axialkolbenpumpen in Tandemausführung
Maximaler Durchfluss	2 x 168 l/min (44.4 US gpm/37.0 UK gpm)
Hilfspumpe für Vorsteuerkreis	Zahnradpumpe

Quererfassendes und kraftstoffsparendes Pumpensystem

HYDRAULIKMOTOREN	
Fahren	Schrägachsen-Kolbenmotor mit Bremsventil und Parkbremse
Schwenken	Axialkolbenmotor mit automatischer Bremse

ÜBERDRUCKVENTILEINSTELLUNG	
Anbaugerätekreise	350 kgf/cm <sup>2</sup> (4970 psi)
Fahren	380 kgf/cm <sup>2</sup> (5400 psi)
Leistungsstufe (Ausleger, Löffelstiel, Löffel)	380 kgf/cm <sup>2</sup> (5400 psi)
Schwenkkreis	285 kgf/cm <sup>2</sup> (4050 psi)
Vorsteuerkreis	40 kgf/cm <sup>2</sup> (570 psi)
Serviceventil	Installiert

HYDRAULIKZYLINDER	
Zylinder: Bohrung x Hub	Ausleger: 2-105 x 1075 mm (4.1" x 42.3")
	Löffelstiel: 1-115 x 1138 mm (4.5" x 46.8")
	Tiefelöffel: 1-100 x 850 mm (3.9" x 33.1")
	Planierschild: 2-100 x 236 mm (3.9" x 9.3")
	Abstützung: 2-110 x 446 mm (4.9" x 18.7")
	Zweitelliger Ausleger: 2-105 x 975 mm (4.1" x 38.4")
Verstellbarer Ausleger: 1-145 x 613 mm (5.7" x 24.1")	

ANTRIEB UND BREMSSEN	
Hydrostatischer Allradantrieb, Schrägverzahntes Wechselgetriebe mit konstantem Zahngriff für 2 Fahrgeschwindigkeiten vorwärts und rückwärts.	
Max. Zugkraft	8500 kgf (18,740 lbf)
Fahrgeschwindigkeit	1 10 km/h
	2 39 km/h
Steigfähigkeit	35° (70 %)

Handbremse: Unabhängige Doppel-Bremsanlage, vollhydraulische Servobremse auf Vorder- und Hinterachse  
 - Nasse Lamellenbremse, per Feder lösend, hydraulisch schließend  
 - Zum Parken wird das Getriebe automatisch in Neutralstellung verriegelt.

STEUERUNG	
Vorsteuerdruckunterstützte Joysticks und Pedale mit abnehmbarem Hebel für nahezu kraft- und ermüdungsfreie Bedienung.	
Vorsteuerung	Zwei Joysticks mit einem Sicherheitshebel (links): Schwenken und Löffelstiel (rechts): Ausleger und Tiefelöffel (ISO)
Motordrehzahlregelung	Elektrisch, Drehschaltertyp
Aussenbeleuchtung	Einer am Ausleger montierte Scheinwerfer, einer unter der Kabine und einer im Werkzeugkasten

ACHSEN UND BEREIFUNG	
Pendelnd gelagerte Vorderachse mit Mittelaufhängung. Mittels Pendelsperrzylinder verriegelbar. Die Hinterachse ist fest mit dem Unterwagen verbunden.	
Reifen	10.00-20-14PR, doppelt (mit Schlauch)
(wahlweise)	10.00-20, doppelt (massiv)

LENKANLAGE	
Die hydraulisch betätigte Orbitrol-Lenkanlage wirkt über die Lenkzylinder auf die Vorderräder.	
Min. Wenderadius	6300 mm (20' 8")

SCHWENKWERK	
Schwenkmotor	Axialkolbenmotor mit festem Schluckvolumen
Schwenkuntersetzung	Planetenraduntersetzung
Drehkransschmierung	Fettbad
Schwenkbremse (Option)	Mehrscheibenausführung, nass
Schwenkgeschwindigkeit	11,7 U/min

SERVICE-FÜLLMENGEN ( ): Option				
Nachfüllmenge	Liter	US gal	UK gal	
Kraftstofftank	270	71.3	59.4	
Motorkühlmittel	19,5	5.2	4.3	
Motoröl	23,7	6.3	5.2	
Schwenkeinrichtung	3,5 (2,5)	0,92 (0,7)	0,77 (0,5)	
Achse	vorne	13,8	3,6	3,0
	hinten	16,1	4,3	3,5
Hydrauliksystem (einschl. Behälter)	2,5	0,7	0,5	
Hydraulikölbehälter	210	55,5	46,2	
DEF/AdBlue®	124	32,8	27,3	
DEF/AdBlue®	27	7,1	5,9	

UNTERWAGEN	
Vollgeschweißter, spannungsarmer Rahmen aus verstärkten Kastenprofilen. Planierschild und Abstützungen sind erhältlich. Bolzenausführung.	
Planierschild	Eine sehr nützliche Ergänzung zum Planieren, Verfüllen oder Räumen.
Abstützung	Empfehlenswert für max. Arbeitsstabilität beim Ausschachten und Heben. Vorn oder hinten anbaubar.

BETRIEBSGEWICHT (CIRCA)	
Betriebsgewicht, einschliesslich 4600 mm (15' 1") Mono Ausleger; 2100 mm (6' 11") Löffelstiel; 0,58 m <sup>3</sup> (0.76 yd <sup>3</sup> ) Löffel gehäuft nach SAE, Schmiermittel, Kühlmittel, vollem Kraftstofftank, vollem Hydraulikölbehälter und aller Standardausrüstung.	

BETRIEBSGEWICHT	
Planierschild hinten	13880 kg (30,600 lb)
Abstützungen hinten	14280 kg (31,480 lb)
Planierschild hinten und Abstützungen vorne	14880 kg (32,800 lb)
Abstützungen hinten und Planierschild vorne	14880 kg (32,800 lb)
Vier Abstützplatten	14630 kg (32,250 lb)

# AUSWAHLHILFE BAGGERLÖFFEL UND SCHACHTKRAFT

# HW140

## LÖFFEL

Die Löffel sind im Stahlausführung, vollig Verschweisst und Zugfest.

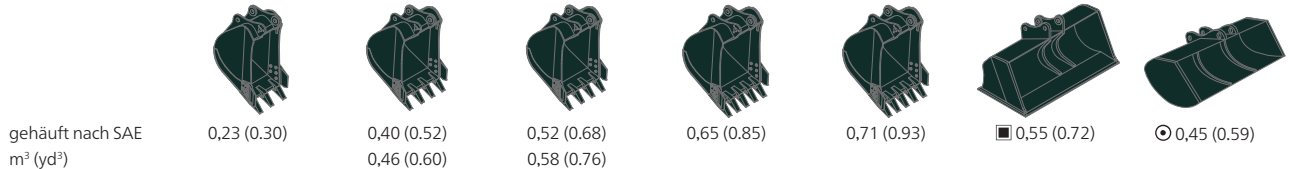

gehäuft nach SAE  
m<sup>3</sup> (yd<sup>3</sup>)

0,23 (0.30)

0,40 (0.52)  
0,46 (0.60)

0,52 (0.68)  
0,58 (0.76)

0,65 (0.85)

0,71 (0.93)

■ 0,55 (0.72)

⊙ 0,45 (0.59)

Inhalt m <sup>3</sup> (yd <sup>3</sup> )		Breite mm (in)		Gewicht kg (lb)	Empfehlung m (ft.in)						
gehäuft nach SAE	gehäuft nach CECE	Ohne Seiten- schneidkanten	Mit Seiten- schneidkanten		4,6 (15' 1") Mono-Ausleger				4,9 (16' 1") Zweiteiliger Ausleger		
					1,9 (6' 3") Löffelstiel	2,1 (6' 11") Löffelstiel	2,5 (8' 2") Löffelstiel	3,0 (9' 10") Löffelstiel	1,9 (6' 3") Löffelstiel	2,1 (6' 11") Löffelstiel	2,5 (8' 2") Löffelstiel
0.23 (0.30)	0.20 (0.26)	520 (20.5)	620 (24.4)	335 (740)	●	●	●	●	●	●	●
0.40 (0.52)	0.35 (0.46)	750 (29.5)	850 (33.5)	410 (900)	●	●	●	●	●	●	●
0.46 (0.60)	0.40 (0.52)	840 (33.1)	940 (37.0)	435 (960)	●	●	●	■	●	●	■
0.52 (0.68)	0.45 (0.59)	915 (36.0)	1,015 (40.0)	460 (1,010)	●	●	■	▲	●	■	■
0.58 (0.76)	0.50 (0.65)	1,000 (39.4)	1,100 (43.3)	480 (1,060)	●	■	■	▲	■	▲	▲
0.65 (0.85)	0.55 (0.72)	1,105 (43.5)	1,205 (47.4)	500 (1,100)	■	▲	▲	-	▲	▲	-
0.71 (0.93)	0.60 (0.78)	1,190 (46.9)	1,290 (50.8)	540 (1,190)	▲	▲	-	-	▲	-	-
■ 0.45 (0.59)	0.40 (0.52)	1,520 (59.8)	-	410 (900)	●	●	■	-	■	■	▲
⊙ 0.55 (0.72)	0.45 (0.59)	1,800 (70.9)	-	585 (1,290)	■	▲	▲	-	■	▲	▲

- Grubenlöffel
- ⊙ Böschungslöffel

- : Für Material mit einer Dichte von maximal 2000 kg / m<sup>3</sup> (3370 lb / yd<sup>3</sup>)
- : Für Material mit einer Dichte von maximal 1600 kg / m<sup>3</sup> (2700 lb / yd<sup>3</sup>)
- ▲ : Für Material mit einer Dichte von maximal 1100 kg / m<sup>3</sup> (1850 lb / yd<sup>3</sup>)

## ANBAUGERÄT

Ausleger und Löffelstiel sind als verschweißtes, spannungsarmes Kastenprofil ausgeführt.

Erhältlich: Ausleger in 4,6 m (15' 1") und Zweiteiliger Ausleger in 4,9 m (16' 1") und Löffelstiel in 1,9 m (6' 3"); 2,1 m (6' 11"); 2,5 m (8' 2") und 3,0 m (9' 10").

## SCHACHTKRAFT

Löffelstiel	Länge	mm (ft.in)	1900 (6' 3")	2100 (6' 11")	2500 (8' 2")	3000 (9' 10")	Anmerkungen:
	Gewicht	kg (lb)	560 (1,230)	580 (1,280)	610 (1,340)	670 (1,480)	
Tieföffel Losbrech- kraft	SAE	kN	87,3 [94,8]	87,3 [94,8]	87,3 [94,8]	87,3 [94,8]	]: Leistungsstufe
		kgf	8900 [9660]	8900 [9660]	8900 [9660]	8900 [9660]	
		lbf	19620 [21300]	19620 [21300]	19620 [21300]	19620 [21300]	
	ISO	kN	102 [110,8]	102 [110,8]	102 [110,8]	102 [110,8]	
		kgf	10400 [11290]	10400 [11290]	10400 [11290]	10400 [11290]	
		lbf	22930 [24890]	22930 [24890]	22930 [24890]	22930 [24890]	
Tieföffelstiel Reißkraft	SAE	kN	76,5 [83,1]	73,6 [79,9]	62,8 [68,2]	55,9 [60,7]	
		kgf	7800 [8,470]	7500 [8,140]	6400 [6,950]	5700 [6,190]	
		lbf	17200 [18,670]	16530 [17,950]	14110 [15,320]	12570 [13,640]	
	ISO	kN	80,4 [87,3]	77,5 [84,1]	65,7 [71,4]	57,9 [62,8]	
		kgf	8200 [8900]	7900 [8580]	6700 [7270]	5900 [6410]	
		lbf	18080 [19630]	17420 [18910]	14770 [16040]	13010 [14120]	

Hinweis : Stielgewicht inklusive Löffelzylinder, Verbindungsstangen und Bolzen.

# MASSE UND ARBEITSBEREICH

# HW140

## ABMESSUNGEN HW140 AUSLEGER

4,6 m (15' 1") Mono-Ausleger and 1,9 m (6' 3"), 2,1 m (6' 11"), 2,5 m (8' 2") und 3,0 m (9' 10") Löffelstiel, Front Abstützung and rear Planierschild.

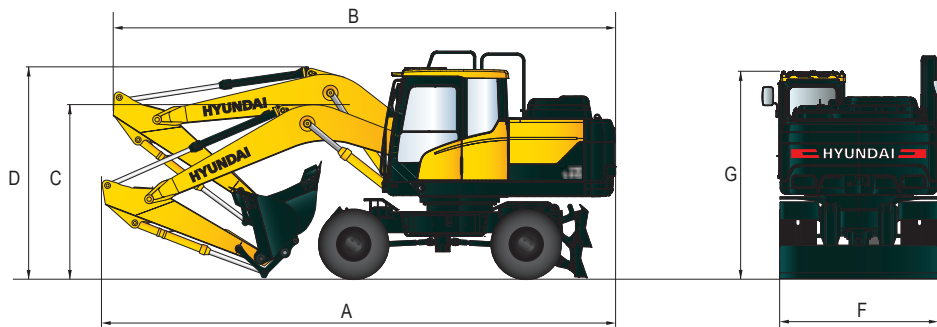

Einheit : mm (ft-in)

Auslegerlänge	4600 (15' 1") Mono-Ausleger			
Löffelstiellänge	1900 (6' 3")	2100 (6' 11")	2500 (8' 2")	3000 (9' 10")
A Gesamtlänge (Fahrstellung)	7760 (25' 6")	7820 (25' 8")	7770 (25' 6")	7830 (25' 8")
B Gesamtlänge (Transportstellung)	7750 (25' 5")	7760 (25' 6")	7690 (25' 3")	7710 (25' 4")
C Gesamthöhe des Auslegers (Fahrstellung)	2760 (9' 1")	2860 (9' 5")	2810 (9' 3")	3100 (10' 2")
D Gesamthöhe des Auslegers (Transportstellung)	3500 (11' 6")	3500 (11' 6")	3620 (11' 11")	3600 (11' 10")
F Gesamtbreite	2500 (8' 2")	2500 (8' 2")	2500 (8' 2")	2500 (8' 2")
G Gesamthöhe der Kabine	3140 (10' 4")	3140 (10' 4")	3140 (10' 4")	3140 (10' 4")

## ARBEITSBEREICH HW140 AUSLEGER

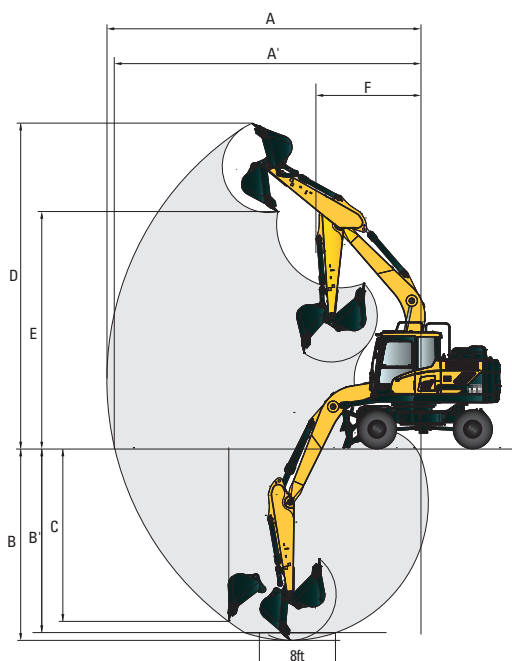

Einheit : mm (ft-in)

Auslegerlänge	4600 (15' 1") Mono-Ausleger			
Löffelstiellänge	1900 (6' 3")	2100 (6' 11")	2500 (8' 2")	3000 (9' 10")
A Max. Schachtweite	7750 (25' 5")	8140 (26' 8")	8320 (27' 4")	8780 (28' 10")
A' Max. Schachtweite am Boden	7530 (24' 8")	7700 (25' 3")	8120 (26' 8")	8590 (28' 2")
B Max. Schachttiefe	4650 (15' 3")	4810 (15' 9")	5250 (17' 3")	5750 (18' 10")
B' Max. Schachttiefe (auf ca. 2,40 m)	4390 (14' 5")	4600 (15' 1")	5040 (16' 6")	5570 (18' 3")
C Max. vertikale Abstehtiefe	4350 (14' 3")	4190 (13' 9")	5030 (16' 6")	5550 (18' 3")
D Max. Einstechhöhe	8400 (27' 7")	8470 (27' 9")	8790 (28' 10")	9070 (29' 9")
E Max. Ladehöhe	5960 (19' 7")	6040 (19' 10")	6350 (20' 10")	6620 (21' 9")
F Min. Frontschwenkradius	2620 (8' 7")	2670 (8' 10")	2650 (8' 8")	2670 (8' 9")

# MASSE UND ARBEITSBEREICH

# HW140

## ABMESSUNGEN HW140 ZWEITEILIGER AUSLEGER

4,9 m (16' 1") Zweiteiliger Ausleger and 1,9 m (6' 3"), 2,1 m (6' 11") und 2,5 m (8' 2") Löffelstiel, Front Abstützung and rear Planierschild.

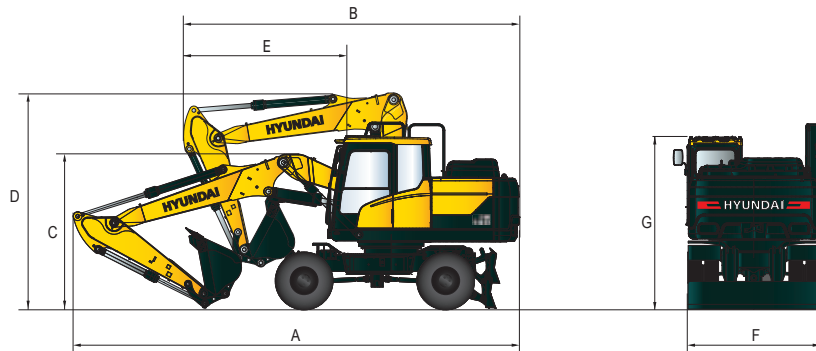

Einheit : mm (ft-in)

Abmessung	4900 (16' 1") Zweiteiliger Ausleger		
Auslegerlänge			
Löffelstiellänge	1900 (6' 3")	2100 (6' 11")	2500 (8' 2")
A Gesamtlänge (Fahrstellung)	8140 (26' 8")	8170 (26' 10")	8150 (26' 9")
B Gesamtlänge (Transportstellung)	6090 (19' 12")	6110 (20' 1")	6130 (20' 1")
C Gesamthöhe des Auslegers (Fahrstellung)	2960 (9' 9")	3060 (10' 0")	3070 (10' 1")
D Gesamthöhe des Auslegers (Transportstellung)	3980 (13' 1")	3980 (13' 1")	3980 (13' 1")
E Ende der Arbeitsausrüstung bis zum Lenkrad	2950 (9' 8")	2970 (9' 9")	2990 (9' 10")
F Gesamtbreite	2500 (8' 2")	2500 (8' 2")	2500 (8' 2")
G Gesamthöhe der Kabine	3140 (10' 4")	3140 (10' 4")	3140 (10' 4")

## ARBEITSBEREICH HW140 ZWEITEILIGER AUSLEGER

Einheit : mm (ft-in)

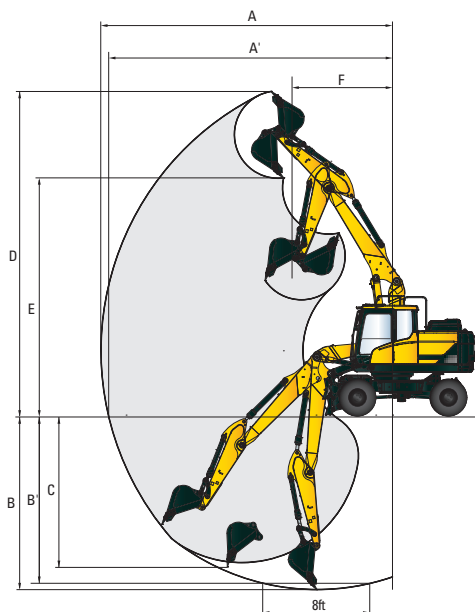

Abmessung	4900 (16' 1") Zweiteiliger Ausleger		
Auslegerlänge			
Löffelstiellänge	1900 (6' 3")	2100 (6' 11")	2500 (8' 2")
A Max. Schachtweite	8140 (26' 8")	8310 (27' 3")	8720 (28' 7")
A' Max. Schachtweite am Boden	7930 (26' 0")	8110 (26' 7")	8530 (28' 0")
B Max. Schachttiefe	4810 (15' 9")	5010 (16' 5")	5410 (17' 9")
B' Max. Schachttiefe (auf ca. 2,40 m)	4700 (15' 5")	4890 (16' 1")	5310 (17' 5")
C Max. vertikale Abstehtiefe	4190 (13' 9")	4360 (14' 4")	4820 (15' 10")
D Max. Einstechhöhe	9100 (29' 10")	9180 (30' 1")	9560 (31' 4")
E Max. Ladehöhe	6620 (21' 9")	6700 (22' 0")	7070 (23' 2")
F Min. Frontschwenkradius	2660 (8' 9")	2820 (9' 3")	2690 (8' 10")

HW140 PLANIERSCHILD HINTEN

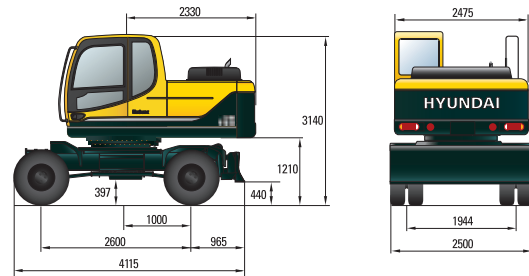

HW140 ABSTÜTZUNGEN HINTEN

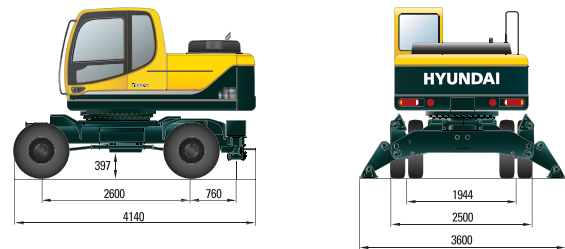

HW140 PLANIERSCHILD HINTEN  
UND ABSTÜTZUNGEN VORNE

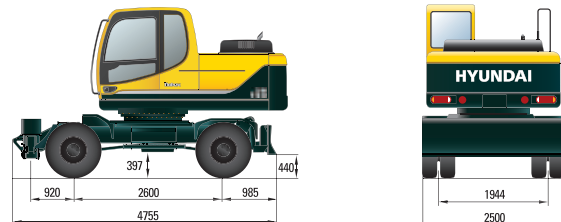

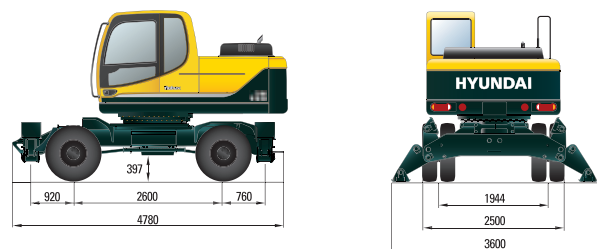

HW140 ABSTÜTZUNGEN  
VORNE UND HINTEN



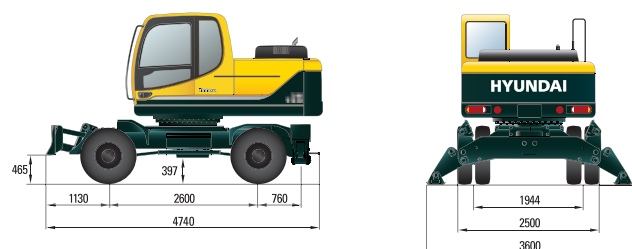









HW140 ABSTÜTZUNGEN HINTEN  
UND PLANIERSCHILD VORNE













 Lastradius Frontauslage  Lastradius Seitenauslage bzw. 360 Grad

## HW140 MONO-AUSLEGER











Ausleger: 4,6 m (15' 1") / Löffelstiel: 1,9 m (6' 3") / Tieflöffel: 0,58 m<sup>3</sup> (0.76 yd<sup>3</sup>) SAE gehäuft / Hinterem Planierschild abgesenkt und 1700 kg Gegengewicht

Lasthöhe m (ft)	Lastradius								Max. Reichweite		
	1.5 m (5.0 ft)		3.0 m (10.0 ft)		4.5 m (15.0 ft)		6.0 m (20.0 ft)		Volumen	Reichweite	
											m (ft)
6.0 m (20 ft)	kg				*3370	*3370			*3200	2030	6.22
	lb				*7430	*7430			*7050	4480	(20.4)
4.5 m (15 ft)	kg				*3760	3480	*2830	2080	*3310	1570	7.05
	lb				*8290	7670	*6240	4590	*7300	3460	(23.1)
3.0 m (10 ft)	kg		*7100	6280	*4730	3260	*3920	2010	3320	1380	7.42
	lb		*15650	13850	*10430	7190	*8640	4430	7320	3040	(24.3)
1.5 m (5 ft)	kg		*7600	5620	*5760	3020	*4350	1910	3270	1340	7.42
	lb		*16760	12390	*12700	6660	*9590	4210	7210	2950	(24.3)
Boden- niveau	kg		*8980	5460	*6340	2880	4580	1850	3530	1450	7.06
	lb		*19800	12040	*13980	6350	10100	4080	7780	3200	(23.2)
-1.5 m (-5 ft)	kg	*7730	*7730	*9450	5500	*6250	2850		*3860	1790	6.24
	lb	*17040	*17040	*20830	12130	*13780	6280		*8510	3950	(20.5)
-3.0 m (-10 ft)	kg		*7740	5680							
	lb		*17060	12520							

Ausleger: 4,6 m (15' 1") / Löffelstiel: 1,9 m (6' 3") / Tieflöffel: 0,58 m<sup>3</sup> (0.76 yd<sup>3</sup>) SAE gehäuft / Hinterem Planierschild abgesenkt und 1700 kg Gegengewicht



Lasthöhe m (ft)	Lastradius								Max. Reichweite		
	1.5 m (5.0 ft)		3.0 m (10.0 ft)		4.5 m (15.0 ft)		6.0 m (20.0 ft)		Volumen	Reichweite	
											m (ft)
6.0 m (20 ft)	kg				*3370	3090			*3200	1740	6.22
	lb				*7430	6810			*7050	3840	(20.4)
4.5 m (15 ft)	kg				*3760	3000	*2830	1770	2650	1330	7.05
	lb				*8290	6610	*6240	3900	5840	2930	(23.1)
3.0 m (10 ft)	kg		*7100	5250	*4730	2780	3400	1700	2380	1160	7.42
	lb		*15650	11570	*10430	6130	7500	3750	5250	2560	(24.3)
1.5 m (5 ft)	kg		*7600	4630	5300	2550	3290	1610	2340	1120	7.42
	lb		*16760	10210	11680	5620	7250	3550	5160	2470	(24.3)
Boden- niveau	kg		*8980	4490	5140	2410	3220	1550	2520	1210	7.06
	lb		*19800	9900	11330	5310	7100	3420	5560	2670	(23.2)
-1.5 m (-5 ft)	kg	*7730	*7730	*9450	4520	5110	2390		3090	1510	6.24
	lb	*17040	*17040	*20830	9960	11270	5270		6810	3330	(20.5)
-3.0 m (-10 ft)	kg		*7740	4690							
	lb		*17060	10340							

Ausleger: 4,6 m (15' 1") / Löffelstiel: 2,1 m (6' 11") / Tieflöffel: 0,58 m<sup>3</sup> (0.76 yd<sup>3</sup>) SAE gehäuft / Hinterem Planierschild abgesenkt und 1700 kg Gegengewicht

Lasthöhe m (ft)	Lastradius								Max. Reichweite		
	1.5 m (5.0 ft)		3.0 m (10.0 ft)		4.5 m (15.0 ft)		6.0 m (20.0 ft)		Volumen	Reichweite	
											m (ft)
6.0 m (20 ft)	kg				*3150	*3150			*3050	1910	6.43
	lb				*6940	*6940			*6720	4210	(21.1)
4.5 m (15 ft)	kg				*3550	3490	*3190	2080	*3170	1490	7.23
	lb				*7830	7690	*7030	4590	*6990	3280	(23.7)
3.0 m (10 ft)	kg		*6650	6320	*4530	3250	*3780	1990	3180	1310	7.59
	lb		*14660	13930	*9990	7170	*8330	4390	7010	2890	(24.9)
1.5 m (5 ft)	kg		*8620	5600	*5590	2990	*4240	1890	3130	1270	7.59
	lb		*19000	12350	*12320	6590	*9350	4170	6900	2800	(24.9)
Boden- niveau	kg		*9100	5390	*6240	2830	4540	1810	3360	1360	7.24
	lb		*20060	11880	*13760	6240	10010	3990	7410	3000	(23.8)
-1.5 m (-5 ft)	kg	*7420	*7420	*9520	5400	*6240	2790		*3770	1660	6.45
	lb	*16360	*16360	*20990	11900	*13760	6150		*8310	3660	(21.2)
-3.0 m (-10 ft)	kg	*11760	*11760	*7980	5570	*5230	2880				
	lb	*25930	*25930	*17590	12280	*11530	6350				











1. Die Hublast richtet sich nach der Definition in SAE J1097 und ISO 10567.
2. Die Hublast der Serie ROBEX darf auf festem, ebenem Untergrund maximal 75 % der Kipplast der Maschine bzw. 87 % der gesamten hydraulischen Hubkraft betragen.

3. Der Lastpunkt ist ein Haken (Standardausrüstung) an der Rückseite des Tieflöffels.
4. (\*) gibt die Lastbegrenzung durch die hydraulische Hubkraft an.











 Lastradius Frontauslage  Lastradius Seitenauslage bzw. 360 Grad

## HW140 MONO AUSLEGER











Ausleger: 4,6 m (15' 1") / Löffelstiel: 2,1 m (6' 11") / Tieflöffel: 0,58 m<sup>3</sup> (0.76 yd<sup>3</sup>) SAE gehäuft / Hinterem Planierschild abgesenkt und 1700 kg Gegengewicht

Lasthöhe m (ft)	Lastradius								Max. Reichweite		
	1.5 m (5.0 ft)		3.0 m (10.0 ft)		4.5 m (15.0 ft)		6.0 m (20.0 ft)		Volumen	Reichweite	
											m (ft)
6.0 m (20 ft)	kg				*3150	3310			*3050	1630	6.43
	lb				*6940	6860			*6720	3590	(21.3)
4.5 m (15 ft)	kg				*3550	3000	*3190	1770	*2530	1250	7.23
	lb				*7830	6610	*7030	3990	*5580	2760	(23.7)
3.0 m (10 ft)	kg		*6650	5280	*4530	2770	3390	1690	2270	1090	7.59
	lb		*14660	11640	*9990	6110	7470	3730	5000	2400	(24.9)
1.5 m (5 ft)	kg		*8620	4620	5270	2520	3270	1590	2230	1050	7.59
	lb		*19000	10190	11620	5560	7210	3510	4920	2310	(24.9)
Boden- niveau	kg		*9100	4410	5090	2370	3180	1510	2390	1130	7.24
	lb		*20060	9720	11220	5220	7010	3330	5270	2490	(23.8)
-1.5 m (-5 ft)	kg	*7420	*7420	*9520	4430	5040	2330		2890	1390	6.45
	lb	*16360	*16360	*20990	9770	11110	5140		6370	3060	(21.2)
-3.0 m (-10 ft)	kg	*11760	*11760	*7980	4580	5150	2420				
	lb	*25930	*25930	*17590	10100	11350	5340				

Ausleger: 4,6 m (15' 1") / Löffelstiel: 2,5 m (8' 2") / Tieflöffel: 0,58 m<sup>3</sup> (0.76 yd<sup>3</sup>) SAE gehäuft / Hinterem Planierschild abgesenkt und 1700 kg Gegengewicht

Lasthöhe m (ft)	Lastradius								Max. Reichweite			
	1.5 m (5.0 ft)		3.0 m (10.0 ft)		4.5 m (15.0 ft)		6.0 m (20.0 ft)		Volumen	Reichweite		
											m (ft)	
6.0 m (20 ft)	kg								*2830	1660	6.92	
	lb								*6240	3660	(22.7)	
4.5 m (15 ft)	kg					*3120	*3120	*2980	2100	*2890	1320	7.66
	lb					*6880	*6880	*6570	4630	*6370	2910	(25.1)
3.0 m (10 ft)	kg			*5730	*5730	*4120	3290	*3510	2000	2900	1170	8.00
	lb			*12630	*12630	*9080	7250	*7740	4410	6390	2580	(26.2)
1.5 m (5 ft)	kg			*8630	5720	*5280	3010	*4040	1880	2850	1130	8.00
	lb			*19030	12610	*11640	6640	*8910	4140	6280	2490	(26.2)
Boden- niveau	kg	*3830	*3830	*9000	5380	*6080	2820	*4440	1790	3040	1210	7.67
	lb	*8440	*8440	*19840	11860	*13400	6220	*9790	3950	6700	2670	(25.2)
-1.5 m (-5 ft)	kg	*6500	*6500	*9740	5340	*6270	2750	*4470	1760	*3520	1440	6.94
	lb	*14330	*14330	*21470	11770	*13820	6060	*9850	3880	*7760	3170	(22.8)
-3.0 m (-10 ft)	kg	*9790	*9790	*8550	5460	*5620	2800			*3490	2100	5.64
	lb	*21580	*21580	*18850	12040	*12390	6170			*7690	4630	(18.5)

Ausleger: 4,6 m (15' 1") / Löffelstiel: 2,5 m (8' 2") / Tieflöffel: 0,58 m<sup>3</sup> (0.76 yd<sup>3</sup>) SAE gehäuft / Hinterem Planierschild abgesenkt und 1700 kg Gegengewicht

Lasthöhe m (ft)	Lastradius								Max. Reichweite			
	1.5 m (5.0 ft)		3.0 m (10.0 ft)		4.5 m (15.0 ft)		6.0 m (20.0 ft)		Volumen	Reichweite		
											m (ft)	
6.0 m (20 ft)	kg								2790	1410	6.92	
	lb								6150	3110	(22.7)	
4.5 m (15 ft)	kg					*3120	3050	*2980	1790	2280	1110	7.66
	lb					*6880	6720	*6570	3950	5030	2450	(25.1)
3.0 m (10 ft)	kg			*5730	5470	*4120	2810	3400	1700	2070	970	8.00
	lb			*12630	12060	*9080	6190	7500	3750	4560	2140	(26.2)
1.5 m (5 ft)	kg			*8630	4720	*5280	2540	3270	1580	2030	930	8.00
	lb			*19030	10410	*11640	5600	7210	3480	4480	2050	(26.2)
Boden- niveau	kg	*3830	*3830	*9000	4410	5080	2350	3160	1490	2150	990	7.67
	lb	*8440	*8440	*19840	9720	11200	5180	6970	3280	4740	2180	(25.2)
-1.5 m (-5 ft)	kg	*6500	*6500	*9740	4360	5000	2290	3130	1460	2540	1200	6.94
	lb	*14330	*14330	*21470	9610	11020	5050	6900	3220	5600	2650	(22.8)
-3.0 m (-10 ft)	kg	*9790	*9790	*8550	4480	5060	2340			*3490	1770	5.64
	lb	*21580	*21580	*18850	9880	11160	5160			*7690	3900	(18.5)











1. Die Hublast richtet sich nach der Definition in SAE J1097 und ISO 10567.
2. Die Hublast der Serie ROBEX darf auf festem, ebenem Untergrund maximal 75 % der Kipplast der Maschine bzw. 87 % der gesamten hydraulischen Hubkraft betragen.

3. Der Lastpunkt ist ein Haken (Standardausrüstung) an der Rückseite des Tieflöffels.
4. (\*) gibt die Lastbegrenzung durch die hydraulische Hubkraft an.













 Lastradius Frontauslage  Lastradius Seitenauslage bzw. 360 Grad

## HW140 MONO AUSLEGER

Ausleger: 4,6 m (15' 1") / Löffelstiel: 3,0 m (9' 10") / Tieflöffel: 0,58 m<sup>3</sup> (0.76 yd<sup>3</sup>) SAE gehäuft / Hinterem Planierschild abgesenkt und 1700 kg Gegengewicht

Lasthöhe m (ft)	Lastradius								Max. Reichweite			
	1.5 m (5.0 ft)		3.0 m (10.0 ft)		4.5 m (15.0 ft)		6.0 m (20.0 ft)		Volumen	Reichweite		
											m (ft)	
6.0 m (20 ft)	kg							*2100	*2100	*2570	1450	7.46
	lb							*4630	*4630	*5670	3200	(24.5)
4.5 m (15 ft)	kg							*2720	2150	*2600	1180	8.14
	lb							*6000	4740	*5730	2600	(26.7)
3.0 m (10 ft)	kg							*3180	2040	2640	1050	8.46
	lb							*7010	4500	5820	2310	(27.8)
1.5 m (5 ft)	kg		*7720	5950	*3600	3380	*3780	1910	2600	1010	8.46	
	lb		*17020	13120	*7940	7450	*8330	4210	5730	2230	(27.8)	
Boden- niveau	kg	*3790	*3790	*9530	5460	*4860	3080	*4280	1800	2740	1070	8.15
	lb	*8360	*8360	*21010	12040	*10710	6790	*9440	3970	6040	2360	(26.7)
-1.5 m (-5 ft)	kg	*5850	*5850	*9890	5320	*5840	2850	4460	1740	3150	1260	7.48
	lb	*12900	*12900	*21800	11730	*12870	6280	9830	3840	6940	2760	(24.5)
-3.0 m (-10 ft)	kg	*8400	*8490	*9140	5380	*6260	2750			*3390	1710	6.31
	lb	*18720	*18720	*20150	11860	*13800	6060			*7470	3770	(20.7)
-4.5 m (-15 ft)	kg			*6870	5620	*5950	2750					
	lb			*15150	12390	*13120	6060					

Ausleger: 4,6 m (15' 1") / Löffelstiel: 3,0 m (9' 10") / Tieflöffel: 0,58 m<sup>3</sup> (0.76 yd<sup>3</sup>) SAE gehäuft / Hinterem Planierschild abgesenkt und 1700 kg Gegengewicht

Lasthöhe m (ft)	Lastradius								Max. Reichweite					
	1.5 m (5.0 ft)		3.0 m (10.0 ft)		4.5 m (15.0 ft)		6.0 m (20.0 ft)		7.5 m (25.0 ft)		Volumen	Reichweite		
													m (ft)	
6.0 m (20 ft)	kg							*2100	1880			2450	1220	7.46
	lb							*4630	4140			5400	2690	(24.5)
4.5 m (15 ft)	kg							*2720	1840			2060	980	8.14
	lb							*6000	4060			4540	2160	(26.7)
3.0 m (10 ft)	kg				*3600	2900	*3180	1740	*1760	1090		1880	860	8.46
	lb				*7940	6390	*7010	3840	*3880	2400		4140	1900	(27.8)
1.5 m (5 ft)	kg		*7720	4930	*4860	2610	3300	1610	*2170	1040		1840	820	8.46
	lb		*17020	10870	*10710	5750	7280	3550	*4780	2290		4060	1810	(27.8)
Boden- niveau	kg	*3790	*3790	*9530	4480	5120	2390	3170	1500	*1780	990	1940	870	8.15
	lb	*8360	*8360	*21010	9880	11290	5270	6990	3310	*3920	2180	4280	1920	(26.7)
-1.5 m (-5 ft)	kg	*5850	*5850	*9890	4350	5000	2280	3110	1440			2230	1030	7.48
	lb	*12900	*12900	*21800	9590	11020	5030	6860	3170			4920	2270	(24.5)
-3.0 m (-10 ft)	kg	*8400	*8490	*9140	4400	5000	2290					2980	1430	6.31
	lb	*18720	*18720	*20150	9700	11020	5050					6570	3150	(20.7)
-4.5 m (-15 ft)	kg			*6870	4630									
	lb			*15150	10210									









- Die Hublast richtet sich nach der Definition in SAE J1097 und ISO 10567.
- Die Hublast der Serie ROBEX darf auf festem, ebenem Untergrund maximal 75 % der Kipplast der Maschine bzw. 87 % der gesamten hydraulischen Hubkraft betragen.
- Der Lastpunkt ist ein Haken (Standardausrüstung) an der Rückseite des Tieflöffels.
- (\*) gibt die Lastbegrenzung durch die hydraulische Hubkraft an.











 Lastradius Frontauslage  Lastradius Seitenauslage bzw. 360 Grad

## HW140 ZWEITEILIGER AUSLEGER









Ausleger: 4,9 m (16' 1") / Löffelstiel: 1,9 m (6' 3") / Tieflöffel: 0,58 m<sup>3</sup> (0.76 yd<sup>3</sup>) SAE gehäuft / Hinterem Planierschild abgesenkt und 1700 kg Gegengewicht

Lasthöhe m (ft)	Lastradius						Max. Reichweite		Reichweite m (ft)	
	3.0 m (10.0 ft)		4.5 m (15.0 ft)		6.0 m (20.0 ft)		Volumen			
										
6.0 m (20 ft)	kg		*2980	*2980			*2910	1750	6.70	
	lb		*6570	*6570			*6420	3860	(22.0)	
4.5 m (15 ft)	kg	*4270	*4270	*3510	3460	*3250	2120	*3010	1380	7.46
	lb	*9410	*9410	*7740	7630	*7170	4560	*6640	3040	(24.5)
3.0 m (10 ft)	kg		*4530	3180	*3640	1970	3030	1220	7.81	
	lb		*9990	7010	*8020	4340	6680	2690	(25.6)	
1.5 m (5 ft)	kg		*5560	2910	*4120	1860	2990	1180	7.81	
	lb		*12260	6420	*9080	4100	6590	2600	(25.6)	
Boden- niveau	kg	*6160	5290	*6150	2770	*4450	1780	3210	1270	7.47
	lb	*13580	11660	*13560	6110	*9810	3920	7080	2800	(24.5)
-1.5 m (-5 ft)	kg	*9310	5360	*6170	2760	*4410	1780	*3590	1550	6.72
	lb	*20530	11820	*13600	6080	*9720	3920	*7910	3420	(22.0)
-3.0 m (-10 ft)	kg		*5400	2860						
	lb		*11900	6310						

Ausleger: 4,9 m (16' 1") / Löffelstiel: 1,9 m (6' 3") / Tieflöffel: 0,58 m<sup>3</sup> (0.76 yd<sup>3</sup>) SAE gehäuft / Hinterem Planierschild abgesenkt und 1700 kg Gegengewicht



Lasthöhe m (ft)	Lastradius						Max. Reichweite		Reichweite m (ft)	
	3.0 m (10.0 ft)		4.5 m (15.0 ft)		6.0 m (20.0 ft)		Volumen			
										
6.0 m (20 ft)	kg		*2980	*2980			*2910	1480	6.70	
	lb		*6570	*6570			*6420	3260	(22.0)	
4.5 m (15 ft)	kg	*4270	*4270	*3510	2960	*3250	1760	2390	1150	7.46
	lb	*9410	*9410	*7740	6530	*7170	3880	5270	2540	(24.5)
3.0 m (10 ft)	kg		*4530	2690	3380	1660	2160	1000	7.81	
	lb		*9990	5930	7450	3660	4760	2200	(25.6)	
1.5 m (5 ft)	kg		5220	2440	3260	1550	2120	970	7.81	
	lb		11510	5380	7190	3420	4670	2140	(25.6)	
Boden- niveau	kg	*6160	4310	5050	2300	3170	1480	2270	1050	7.47
	lb	*13580	9500	11130	5070	6990	3260	5000	2310	(24.5)
-1.5 m (-5 ft)	kg	*9310	4370	5030	2290	3170	1470	2720	1290	6.72
	lb	*20530	9630	11090	5050	6990	3240	6000	2840	(22.0)
-3.0 m (-10 ft)	kg		5150	2380						
	lb		11350	5250						

Ausleger: 4,9 m (16' 1") / Löffelstiel: 2,1 m (6' 11") / Tieflöffel: 0,58 m<sup>3</sup> (0.76 yd<sup>3</sup>) SAE gehäuft / Hinterem Planierschild abgesenkt und 1700 kg Gegengewicht

Lasthöhe m (ft)	Lastradius						Max. Reichweite		Reichweite m (ft)	
	3.0 m (10.0 ft)		4.5 m (15.0 ft)		6.0 m (20.0 ft)		Volumen			
										
6.0 m (20 ft)	kg		*2790	*2790			*2780	1640	6.91	
	lb		*6150	*6150			*6130	3620	(22.7)	
4.5 m (15 ft)	kg		*3320	*3320	*3100	2070	*2880	1300	7.65	
	lb		*7320	*7320	*6830	4560	*6350	2870	(25.1)	
3.0 m (10 ft)	kg		*4330	3170	*3510	1950	2910	1150	7.99	
	lb		*9550	6990	*7740	4300	6420	2540	(26.2)	
1.5 m (5 ft)	kg		*5400	2880	*4010	1830	2860	1110	7.99	
	lb		*11900	6350	*8840	4030	6310	2450	(26.2)	
Boden- niveau	kg	*6330	5200	*6050	2720	*4370	1740	3060	1190	7.66
	lb	*13960	11460	*13340	6000	*9630	3840	6750	2620	(25.1)
-1.5 m (-5 ft)	kg	*9370	5250	*6140	2690	*4400	1730	*3480	1430	6.93
	lb	*20660	11570	*13540	5930	*9700	3810	*7670	3150	(22.7)
-3.0 m (-10 ft)	kg		*5500	2780						
	lb		*12130	6130						









1. Die Hublast richtet sich nach der Definition in SAE J1097 und ISO 10567.
2. Die Hublast der Serie ROBEX darf auf festem, ebenem Untergrund maximal 75 % der Kipplast der Maschine bzw. 87 % der gesamten hydraulischen Hubkraft betragen.

3. Der Lastpunkt ist ein Haken (Standardausrüstung) an der Rückseite des Tieflöffels.
4. (\*) gibt die Lastbegrenzung durch die hydraulische Hubkraft an.











 Lastradius Frontauslage  Lastradius Seitenauslage bzw. 360 Grad

## HW140 ZWEITEILIGER AUSLEGER











Ausleger: 4,9 m (16' 1") / Löffelstiel: 2,1 m (6' 11") / Tieföffel: 0,58 m<sup>3</sup> (0.76 yd<sup>3</sup>) SAE gehäuft / Hinterem Planierschild abgesenkt und 1700 kg Gegengewicht

Lasthöhe m (ft)	Lastradius						Max. Reichweite		Reichweite m (ft)	
	3.0 m (10.0 ft)		4.5 m (15.0 ft)		6.0 m (20.0 ft)		Volumen			
										
6.0 m (20 ft)	kg		*2790	*2790			*2780	1390	6.91	
	lb		*6150	*6150			*6130	3060	(22.7)	
4.5 m (15 ft)	kg		*3320	2960	*3100	1750	2280	1080	7.65	
	lb		*7320	6530	*6830	3860	5030	2380	(25.1)	
3.0 m (10 ft)	kg		*4330	2680	3370	1640	2060	940	7.99	
	lb		*9550	5910	7430	3620	4540	2070	(26.2)	
1.5 m (5 ft)	kg			5190	2410	3230	1520	2020	7.99	
	lb			11440	5310	7120	3350	4450	(26.2)	
Boden- niveau	kg	*6330	4220	5000	2250	3130	1440	2150	970	7.66
	lb	*13960	9300	11020	4960	6900	3170	4740	2140	(25.1)
-1.5 m (-5 ft)	kg	*9370	4270	4960	2220	3120	1420	2550	1180	6.93
	lb	*20660	9410	10930	4890	6880	3130	5620	2600	(22.7)
-3.0 m (-10 ft)	kg			5070	2310					
	lb			11180	5090					

Ausleger: 4,9 m (16' 9") / Löffelstiel: 2,5 m (8' 2") / Tieföffel: 0,58 m<sup>3</sup> (0.76 yd<sup>3</sup>) SAE gehäuft / Hinterem Planierschild abgesenkt und 1700 kg Gegengewicht

Lasthöhe m (ft)	Lastradius								Max. Reichweite		Reichweite m (ft)	
	3.0 m (10.0 ft)		4.5 m (15.0 ft)		6.0 m (20.0 ft)		7.5 m (25.0 ft)		Volumen			
												
6.0 m (20 ft)	kg				*2550	2140			*2580	1440	7.39	
	lb				*5620	4720			*5690	3170	(24.2)	
4.5 m (15 ft)	kg		*2920	*2920	*2810	2090			*2680	1150	8.08	
	lb		*6440	*6440	*6190	4610			*5910	2540	(26.5)	
3.0 m (10 ft)	kg	*5880	*5880	*3950	3220	*3260	1970	*1990	1270	2660	1030	8.40
	lb	*12960	*12960	*8710	7100	*7190	4340	*4390	2800	5860	2270	(27.6)
1.5 m (5 ft)	kg	*6080	*5450	*5090	2910	*3810	1830	*2510	1220	2620	990	8.40
	lb	*13400	*12020	*11220	6420	*8400	4030	*5530	2690	5780	2180	(27.6)
Boden- niveau	kg	*6380	5180	*5870	2710	*4250	1720			2770	1050	8.09
	lb	*14070	11420	*12940	5970	*9370	3790			6110	2310	(26.5)
-1.5 m (-5 ft)	kg	*9070	5170	*6130	2650	*4400	1680			3220	1250	7.41
	lb	*20000	11400	*13510	5840	*9700	3700			7100	2760	(24.3)
-3.0 m (-10 ft)	kg	*8650	5310	*5730	2700							
	lb	*19070	11710	*12630	5950							

Ausleger: 4,9 m (16' 1") / Löffelstiel: 2,5 m (8' 2") / Tieföffel: 0,58 m<sup>3</sup> (0.76 yd<sup>3</sup>) SAE gehäuft / Hinterem Planierschild abgesenkt und 1700 kg Gegengewicht

Lasthöhe m (ft)	Lastradius								Max. Reichweite		Reichweite m (ft)	
	3.0 m (10.0 ft)		4.5 m (15.0 ft)		6.0 m (20.0 ft)		7.5 m (25.0 ft)		Volumen			
												
6.0 m (20 ft)	kg				*2550	1820			2470	1200	7.39	
	lb				*5620	4010			5450	2650	(24.2)	
4.5 m (15 ft)	kg		*2920	*2920	*2810	1780			2060	950	8.08	
	lb		*6440	*6440	*6190	3920			4540	2090	(26.5)	
3.0 m (10 ft)	kg	*5880	5250	*3950	2730	*3260	1650	*1990	1040	1880	830	8.40
	lb	*12960	11570	*8710	6020	*7190	3640	*4390	2290	4140	1830	(27.6)
1.5 m (5 ft)	kg	*6080	4450	*5090	2430	3230	1520	2210	990	1840	800	8.40
	lb	*13400	9810	*11220	5360	7120	3350	4870	2180	4060	1760	(27.6)
Boden- niveau	kg	*6380	4200	5000	2240	3120	1420			1950	850	8.09
	lb	*14070	9260	11020	4940	6880	3130			4300	1870	(26.5)
-1.5 m (-5 ft)	kg	*9070	4190	4920	2180	3070	1380			2260	1020	7.41
	lb	*20000	9240	10850	4810	6770	3040			4980	2250	(24.3)
-3.0 m (-10 ft)	kg	*8650	4320	4980	2230							
	lb	*19070	9520	10980	4920							

- Die Hublast richtet sich nach der Definition in SAE J1097 und ISO 10567.
- Die Hublast der Serie ROBEX darf auf festem, ebenem Untergrund maximal 75 % der Kipplast der Maschine bzw. 87 % der gesamten hydraulischen Hubkraft betragen.

- Der Lastpunkt ist ein Haken (Standardausrüstung) an der Rückseite des Tieföffels.
- (\*) gibt die Lastbegrenzung durch die hydraulische Hubkraft an.

MOTOR	STD	OPT
Cummins QSB 6.7 engine	●	
<b>HYDRAULIKSYSTEM</b>		
<b>IPC (Intelligent Power Control)</b>		
3 Leistungsstufen, 2 Arbeitsarten, Benutzermodus	●	
Variable Leistungssteuerung	●	
Pumpenfördermengenregelung	●	
Volumenstromregelung für Anbaugerät-Betriebsart		●
Automatischer Motorleerlauf	●	
Automatische Motorabschaltung		●
Elektronische Gebläsesteuerung	●	
<b>KABINE UND INNENRAUM</b>		
<b>Kabine nach ISO-Norm</b>		
Ober ruhender Frontscheibenwischer	●	
Radio/USB-Player	●	
Mobiltelefon-Freisprecheinrichtung mit USB	●	
12-Volt-Steckdose (Wandler 24 VDC auf 12 VDC)	●	
Elektrisches Signalhorn	●	
Allwetter-Stahlkabine mit 360°-Rundsicht	●	
Sicherheitsglasscheiben	●	
Frontscheibe einschiebbar	●	
Seitenscheibe (links) als Schiebefenster	●	
Abschließbare Tür	●	
Warmhalte- und Kühlbox	●	
Aufbewahrungsfach und Aschenbecher	●	
Kabinendachabdeckung transparent	●	
Sonnenblende	●	
Tür- und Kabinenschlösser, ein Schlüssel	●	
Mechanisch gefederter, beheizter Sitz	●	
Vorsteuerdruckunterstützter Joystick	●	
Konsole höhenverstellbar	●	
<b>Automatische Klimaregelung</b>		
Klimaanlage und Heizung	●	
Scheibenheizung	●	
Starthilfe (Ansaugluftvorwärmung) bei kalten Temperaturen	●	
<b>Zentrale Überwachung</b>		
8-Zoll-LCD	●	
Motordrehzahl oder Tageszähler/Beschleunigung	●	
Motor Kühlmittel-Temperaturanzeige	●	
Max. Leistung	●	
Kriechgang/Schnellgang	●	
Automatischer Leerlauf	●	
Überlast	●	
Motor überprüfen	●	
Luftfilter verstopft	●	
Anzeigen	●	
ÖKO-Anzeigen	●	
Kraftstoffstandanzeige	●	
Anzeige für die Hydrauliköltemperatur	●	
Kraftstoffvorwärmer	●	
Warnungen	●	
Kommunikationsfehler	●	
Batterie niedrig	●	
Uhr	●	
Kabinenscheinwerfer		●
Regenschutz für Kabinenfrontfenster	●	
Kabinendachabdeckung in Stahl		●
<b>Sitz</b>		
Einstellbarer Fahrersitz mit Luftfederung und Heizung		●
<b>Kabinen-FOPS/FOG (ISO/DIN 10262) Stufe 2</b>		
FOPS (Schutzeinrichtung gegen herabfallende Gegenstände) - ISO 3449 Stufe 2		●
FOG (Schutzaufbau gegen herabfallende Gegenstände)		●
<b>Kabinen-ROPS (ISO 12117-2)</b>		
ROPS (Überrollschutz)	●	

SICHERHEIT	STD	OPT
Batterie Hauptschalter	●	
Heckkamera	●	
Kameragestützte virtuelle Draufsicht incl. Bewegobjektüberwachung (AAVM + MOD)		●
Vier Arbeitsscheinwerfer	●	
Fahralarm	●	
Arbeitsscheinwerfer hinten		●
Rundumleuchte		●
Automatische Schwenkbremse	●	
Auslegerhaltesystem	●	
Stielhaltesystem	●	
Sicherheitsventil für Auslegerzylinder mit Überlastwarneinrichtung	●	
Sicherheitsventil für Löffelstielzylinder		●
Schwenksperre		●
Vier Rückspiegel außen	●	
<b>SONSTIGES</b>		
<b>Ausleger</b>		
4,6 m; 15' 1" Mono	●	
4,9 m; 16' 1" Zweiteiliger		●
4,1 m; 13' 5"		●
<b>Löffelstiel</b>		
1,9 m; 6' 3"		●
2,1 m; 6' 11"	●	
2,5 m; 8' 2"		●
3,0 m; 9' 11"		●
Herausnehmbares Kühlerstaubgitter	●	
Herausnehmbarer Vorratsbehälter	●	
Kraftstoffvorfilter	●	
Kraftstoffvorwärmer	einfach zweifach	● ●
Selbstdiagnosesystem		●
Hi-mate (Maschinenmanagementsystem)	Mobiltelefon Satellit	● ●
Batterien (2 x 12 V x 100 Ah)		●
Kraftstoffbetankungspumpe (35 l/min)		●
Einfach wirkende Verrohrung (Hydraulikhammer usw.)		●
Doppelt wirkende Verrohrung (Zweischalengreifer usw.)		●
Verrohrung für drehende Anbaugeräte		●
Verrohrung für hydraulische Schnellwechsler		●
Schnellwechsler		●
Druckspeicher beim Senken der Arbeitseinrichtung	●	
Bedienschema-Umschaltventil (2 Muster)		●
Feinsteuerung Schwenken		●
Werkzeugsatz		●
Automatische Geschwindigkeitsregelung	●	
Fahrpedal (2-Wege)		●
<b>UNTERWAGEN</b>		
Planierschild hinten	●	
Planierschild hinten und Abstützung vorne		●
Abstützungen hinten und vorne		●
Abstützung hinten und Planierschild vorne		●
Reifen doppelt (10.00-20-14PR mit Schlauch)	●	
Reifen doppelt (10.00-20 massiv)		●
Kotflügel (Schmutzfänger)		●

STD = Standard  
OPT = Optional

- \* Standard- und Wahlausstattung können je nach Modell abweichen. Weitere Informationen erhalten Sie von Ihrem Hyundai-Händler. Die Maschinenausstattung kann von internationalen Normen abhängig sein.
- \* Auf den Fotos können Anbauten und optionale Geräte abgebildet sein, die in Ihrer Region nicht erhältlich sind.
- \* Änderungen der Materialien und technischen Daten vorbehalten.
- \* Alle Maße in angloamerikanischen Maßeinheiten sind auf das nächste volle Maß (Pound oder Zoll) gerundet.