

MOTOR		
Hersteller / Modell	CUMMINS QSB6.7 Engine	
Typ	Wassergekühlter, 4-takt Dieselmotor, 6 Zylinder in Reihe, Direkteinspritzer mit Turbolader, Laderluftkühlung und niedriger Emission	
Nennleistung am Schwungrad	SAE J1995 (brutto)	136 kW (183 PS) bei 1950 U/min
	SAE J1349 (netto)	129 kW (173 PS) bei 1950 U/min
	DIN 6271/1 (brutto)	136 kW (185 PS) bei 1950 U/min
	DIN 6271/1 (netto)	129 kW (175 PS) bei 1950 U/min
Höchstdrehmoment	81,6 kgf (590 lbf.ft) bei 1500 U/min	
Bohrung x Hub	107 x 124 mm (4.2" x 4.9")	
Hubraum	6700 cc (409 cu in)	
Batterien	2 x 12 V x 100 Ah	
Anlasser	24 V - 4,8 kW	
Generator	24 V - 95 A	

HYDRAULIKSYSTEM	
HAUPTPUMPE	
Typ	Verstellbare Axialkolbenpumpen in Tandemausführung
Maximaler Durchfluss	2 x 222 l/min (58,6 US gpm / 48,8 UK gpm)
Hilfspumpe für Vorsteuerkreis	Zahnradpumpe
Quererfassendes und kraftstoffsparendes Pumpensystem	

HYDRAULIKMOTOREN	
Fahren	Axialkolbenmotor mit zwei Geschwindigkeiten mit Bremsventil und Parkbremse
Schwenken	Axialkolbenmotor mit automatischer Bremse

ÜBERDRUCKVENTILEINSTELLUNG	
Anbaugerätkreise	350 kgf/cm ² (4980 psi)
Fahren	350 kgf/cm ² (4980 psi)
Leistungsstufe (Ausleger, Löffelstiel, Löffel)	380 kgf/cm ² (5410 psi)
Schwenkkreis	285 kgf/cm ² (4050 psi)
Vorsteuerkreis	40 kgf/cm ² (570 psi)
Serviceventil	Installiert

HYDRAULIKZYLINDER	
Zylinder: Bohrung x Hub	Ausleger: 2-120 x 1290 mm
	Löffelstiel: 1-140 x 1510 mm
	Tiefelöffel: 1-120 x 1055 mm
	Planierschild: 2-130 x 240 mm
	Zweiteiliger Ausleger:
	1: 2-125 x 1260 mm
2: 1-160 x 1060 mm	

ANTRIEBE UND BREMSEN	
Antriebsart	Vollhydrostatisch
Antriebsmotor	Axialkolbenmotor, mit Bremse integriert
Untersetzung	Planetenuntersetzungsgetriebe
Max. Zugkraft	20,500 kgf (45,194 lbf)
Max. Fahrgeschwindigkeit (Schnell-/Langsamgang)	5,5 km/h (3,5 mph) / 3,3 km/h (2,1 mph)
Steigfähigkeit	35° (70%)
Hundbremse	Mehrscheibenausführung, nass

STEUERUNG	
Vorsteuerdruckunterstützte Joysticks und Pedale mit abnehmbarem Hebel für nahezu kraft- und ermüdungsfreie Bedienung.	
Vorsteuerung	Zwei Joysticks mit einem Sicherheitshebel (links): Schwenken und Löffelstiel (rechts): Ausleger und Tiefelöffel (ISO)
Fahren und Lenken	Zwei Hebel mit Pedalen
Motordrossel	Elektrisch, als Drehregler ausgeführt

SCHWENKWERK	
Schwenkmotor	Axialkolbenmotor mit festem Schluckvolumen
Schwenkuntersetzung	Planetenraduntersetzung
Drehkransschmierung	Fettbad
Schwenkbremse	Mehrscheibenausführung, nass
Schwenkgeschwindigkeit	10,8 U/min

SERVICE-FÜLLMENGEN			
Nachfüllmenge	Liter	US gal	UK gal
Kraftstofftank	320	84,5	70,4
Motorkühlmittel	40	10,6	8,8
Motoröl	23,7	6,3	5,2
Schwenkeinrichtung	7	1,8	1,5
Endantrieb (je)	4,5	1,2	1,0
Hydrauliksystem (einschl. Behälter)	275	72,6	60,5
Hydraulikölbehälter	160	42,3	35,2
DEF/AdBlue®	27	7,1	5,9

UNTERWAGEN	
Der X-Mittelrahmen ist eine vollerschweißte Konstruktion mit verstärkten Kastenrahmen für das Laufwerk. Der Unterwagen ist mit geschmierten Rollen, Leiträdern, Kettenspannern mit stoßdämpfenden Federn und Antriebsrädern sowie Raupenkettenspannern mit 2- oder 3-Steg-Bodenplatten ausgerüstet.	
Mittelrahmen	X-Rahmen
Unterwagen	Fünfeckiges Kastenprofil
Kettenplatten pro Seite	49 EA
Stützrollen pro Seite	2 EA
Laufrollen pro Seite	9 EA
Kettenführungen pro Seite	2 EA

BETRIEBSGEWICHT (CIRCA)	
Betriebsgewicht, einschliesslich 5680 mm (18' 8") Ausleger; 2920 mm (9' 7") Löffelstiel; 0,80 m ³ (1.05 yd ³) Löffel gehäuft nach SAE, Schmiermittel, Kühlmittel, vollem Kraftstofftank, vollem Hydraulikölbehälter und aller Standardausrüstung.	

BETRIEBSGEWICHT			
Platten		Betriebsgewicht	Bodendruck
Typ	Breite mm (in)	kg (lb)	kgf / cm ² (psi)
Dreisteg	600 (24")	24000 (52,910)	0,51 (7,25)
	700 (28")	24280 (53,530)	0,44 (6,26)
	800 (32")	24560 (54,140)	0,39 (5,55)
	900 (36")	24840 (54,760)	0,35 (4,98)

AUSWAHLHILFE BAGGERLÖFFEL UND SCHACHTKRAFT

HX235 LCR

LÖFFEL

Die Löffel sind im Stahlausführung, vollig Verschweisst und Zugfest.



gehäuft nach SAE
m³ (yd³)

0,51 (0.67)



0,80 (1.05)
0,87 (1.14)
0,92 (1.20)



1,10 (1.44)
1,20 (1.57)

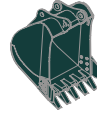

1,34 (1.75)



◆ 0,74 (0.97)
◆ 0,90 (1.18)
◆ 1,05 (1.37)



● 0,87 (1.14)

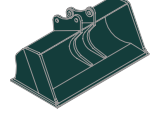

■ 0,75 (0.98)

Inhalt m ³ (yd ³)		Breite mm (in)		Gewicht kg (lb)	Empfehlung mm (ft.in)					
					5680 (18' 8") Mono-Ausleger			5650 (18' 6") Zweiteiliger Ausleger		
gehäuft nach SAE	gehäuft nach CECE	Ohne Seiten- schneidkanten	Mit Seiten- schneidkanten		2000 (6' 7") Löffelstiel	2400 (7' 10") Löffelstiel	2920 (9' 7") Löffelstiel	2000 (6' 7") Löffelstiel	2400 (7' 10") Löffelstiel	2920 (9' 7") Löffelstiel
0,51 (0.67)	0,45 (0.59)	700 (27.6)	820 (32.3)	570 (1,260)	●	●	●	●	●	●
0,80 (1.05)	0,70 (0.92)	1000 (39.4)	1120 (44.1)	700 (1,540)	●	●	●	●	●	■
0,87 (1.14)	0,75 (0.98)	1090 (42.9)	1210 (47.6)	740 (1,630)	●	●	■	●	●	■
0,92 (1.20)	0,80 (1.05)	1150 (45.3)	1270 (50.0)	770 (1,700)	●	●	■	●	●	▲
1,10 (1.44)	0,96 (1.26)	1320 (52.0)	1440 (56.7)	830 (1,830)	●	■	▲	■	■	▲
1,20 (1.57)	1,00 (1.31)	1400 (55.1)	1520 (59.8)	850 (1,870)	■	▲	-	■	▲	-
1,34 (1.75)	1,15 (1.50)	1550 (61.0)	1670 (65.7)	920 (2,030)	▲	▲	-	▲	-	-
◆ 0,74 (0.97)	0,65 (0.85)	985 (38.8)	-	770 (1,700)	●	●	●	●	●	■
◆ 0,90 (1.18)	0,80 (1.05)	1095 (43.1)	-	810 (1,790)	●	●	■	●	●	▲
◆ 1,05 (1.37)	0,92 (1.20)	1290 (50.8)	-	890 (1,960)	●	■	▲	■	■	▲
● 0,87 (1.14)	0,75 (0.98)	1140 (44.9)	-	900 (1,980)	●	●	■	●	●	▲
■ 0,75 (0.98)	0,65 (0.85)	1790 (70.5)	-	880 (1,940)	●	●	■	●	●	▲

- ◆ Tieflöffel für hohe Beanspruchung
- Felslöffel für hohe Beanspruchung
- Böschungslöffel

- : Für Material mit einer Dichte von maximal 2000 kg /m³ (3370 lb/ yd³)
- : Für Material mit einer Dichte von maximal 1600 kg /m³ (2700 lb/ yd³)
- ▲ : Für Material mit einer Dichte von maximal 1100 kg /m³ (1850 lb/ yd³)

ANBAUGERÄT

Ausleger und Löffelstiel sind als verschweißtes, spannungsarmes Kastenprofil ausgeführt.

Erhältlich: Ausleger in 5,68 m (18' 8") und Zweiteiliger Ausleger in 5,65 m (18' 6") und Löffelstiel in 2,0 m (6' 7"); 2,4 m (7' 10") und 2,92 m (9' 7").

SCHACHTKRAFT

Ausleger	Länge	mm (ft.in)	2000 (6' 7")	2400 (7' 10")	2920 (9' 7")	Anmerkungen:
	Gewicht	kg (lb)	975 (2,150)	1045 (2,300)	1095 (2,410)	
Tieflöffel Losbrech- kraft	SAE	kN	133,4 [144,8]	133,4 [144,8]	133,4 [144,8]	[]: Leistungs- stufe
		kgf	13600 [14770]	13600 [14770]	13600 [14770]	
		lbf	29980 [32550]	29980 [32550]	29980 [32550]	
	ISO	kN	152,0 [165,0]	152,0 [165,0]	152,0 [165,0]	
		kgf	15500 [16830]	15500 [16830]	15500 [16830]	
		lbf	34170 [37100]	34170 [37100]	34170 [37100]	
Tieflöffelstiel Reißkraft	SAE	kN	144,2 [156,5]	119,6 [129,9]	102,0 [110,7]	
		kgf	14700 [15960]	12200 [13250]	10400 [11290]	
		lbf	32410 [35190]	26900 [29210]	22930 [24900]	
	ISO	kN	151,0 [164,0]	125,5 [136,3]	106,9 [116,1]	
		kgf	15400 [16720]	12800 [13900]	10900 [11830]	
		lbf	33950 [36860]	28220 [30640]	24030 [26090]	

Hinweis: Stielgewicht inklusive Löffelzylinder, Verbindungsstangen und Bolzen.

MASSE UND ARBEITSBEREICH

HX235 LCR

ABMESSUNGEN HX235 LCR

Mono-Ausleger in 5,68 m (18' 8") und Löffelstiel in 2,0 m (6' 7"); 2,4 m (7' 10") und 2,92 m (9' 7").

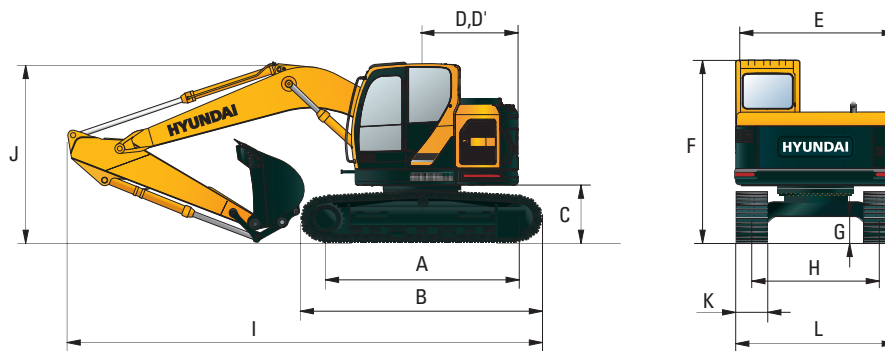

Einheit : mm (ft-in)

A	Aufstandslänge	3650 (12' 0")
B	Gesamtlänge der Raupe	4404 (14' 6")
C	Bodenfreiheit des Heckgegengewichts	1080 (3' 7")
D	Heckschwenkradius	1780 (6' 04")
D'	Hecklänge	1780 (6' 04")
E	Gesamtbreite des Oberwagens	2980 (9' 9")
F	Gesamthöhe der Kabine	3290 (10' 10")
G	Mindest-Bodenfreiheit	480 (1' 7")
H	Spurweite	2390 (7' 10")

Auslegerlänge	5680 (18' 8")			
Löffelstiellänge	2000 (6' 7")	2400 (7' 10")	2920 (9' 7")	
I Gesamtlänge	9040 (29' 8")	8950 (29' 4")	8910 (29' 3")	
J Gesamthöhe des Auslegers	3200 (10' 6")	3100 (10' 2")	3020 (9' 11")	
K Breite der Bodenplatten	600 (24")	700 (28")	800 (32")	900 (36")
L Gesamtbreite	2990 (9' 10")	3090 (10' 2")	3190 (10' 6")	3290 (10' 10")

ARBEITSBEREICH HX235 LCR

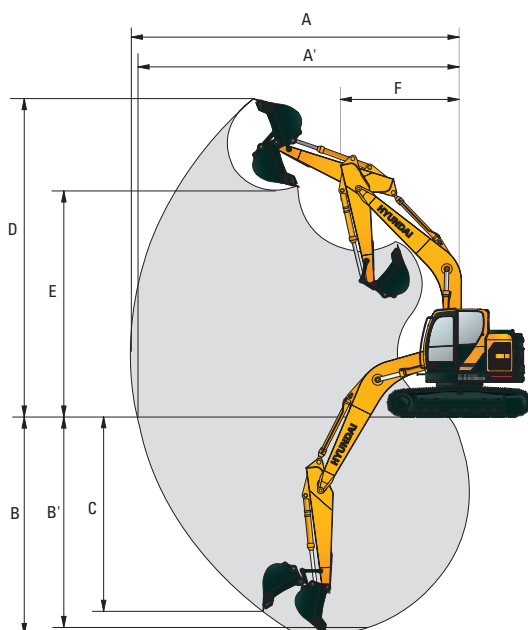

Einheit : mm (ft-in)

Auslegerlänge	5680 (18' 8")		
Löffelstiellänge	2000 (6' 7")	2400 (7' 10")	2920 (9' 7")
A Max. Schachtweite	9040 (29' 8")	9430 (30' 11")	9910 (32' 6")
A' Max. Schachtweite am Boden	8860 (29' 1")	9260 (30' 5")	9750 (32' 0")
B Max. Schachttiefe	5780 (19' 0")	6180 (20' 3")	6700 (22' 0")
B' Max. Schachttiefe (auf ca. 2,40 m)	5550 (19' 0")	5980 (19' 7")	6530 (21' 5")
C Max. vertikale Abstechtiefe	5140 (16' 10")	5710 (18' 9")	6270 (20' 7")
D Max. Einstechhöhe	10090 (33' 1")	10420 (34' 2")	10830 (35' 6")
E Max. Ladehöhe	7190 (23' 7")	7510 (24' 8")	7890 (25' 11")
F Min. Frontschwenkradius	2860 (9' 5")	2550 (8' 4")	2350 (7' 9")

MASSE UND ARBEITSBEREICH

HX235 LCR

ABMESSUNGEN HX235 LCR (MIT PLANIERSCHILD)

Mono-Ausleger in 5,68 m (18' 8") und Löffelstiel in 2,0 m (6' 7"); 2,4 m (7' 10") und 2,92 m (9' 7").

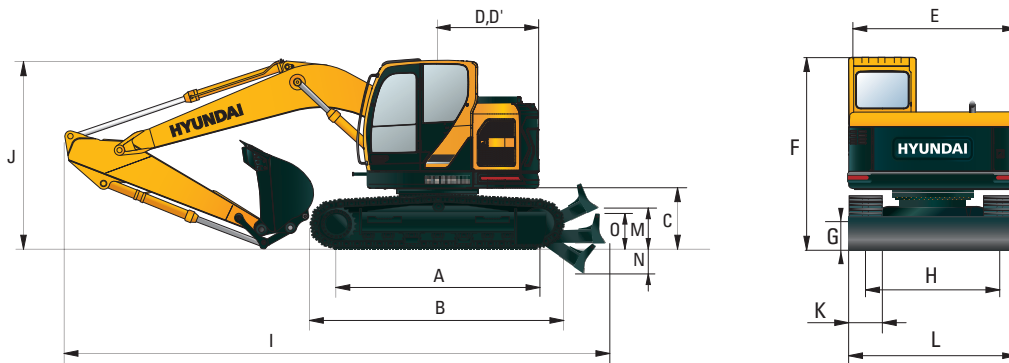

Einheit : mm (ft-in)

A	Aufstandslänge	3650 (12' 0")
B	Gesamtlänge der Raupe	4404 (14' 6")
C	Bodenfreiheit des Heckgegengewichts	1080 (3' 7")
D	Heckschwenkradius	1780 (6' 04")
D'	Hecklänge	1780 (6' 04")
E	Gesamtbreite des Oberwagens	2980 (9' 9")
F	Gesamthöhe der Kabine	3290 (10' 10")
G	Mindest-Bodenfreiheit	480 (1' 7")
H	Spurweite	2390 (7' 10")
M	Bodenfreiheit mit gehobenem Planierschild	550 (1' 10")
N	Tiefe mit abgesenktem Planierschild	410 (1' 4")
O	Höhe des Planierschildes	740 (2' 5")

Auslegerlänge	5680 (18' 8")			
Löffelstiellänge	2000 (6' 7")	2400 (7' 10")	2920 (9' 7")	
I Gesamtlänge	10020 (32' 10")	9930 (32' 7")	9890 (32' 5")	
J Gesamthöhe des Auslegers	3200 (10' 6")	3100 (10' 2")	3020 (9' 11")	
K Breite der Bodenplatten	600 (24")	700 (28")	800 (32")	900 (36")
L Gesamtbreite	2990 (9' 10")	3090 (10' 2")	3190 (10' 6")	3290 (10' 10")

ARBEITSBEREICH HX235 LCR (MIT PLANIERSCHILD)

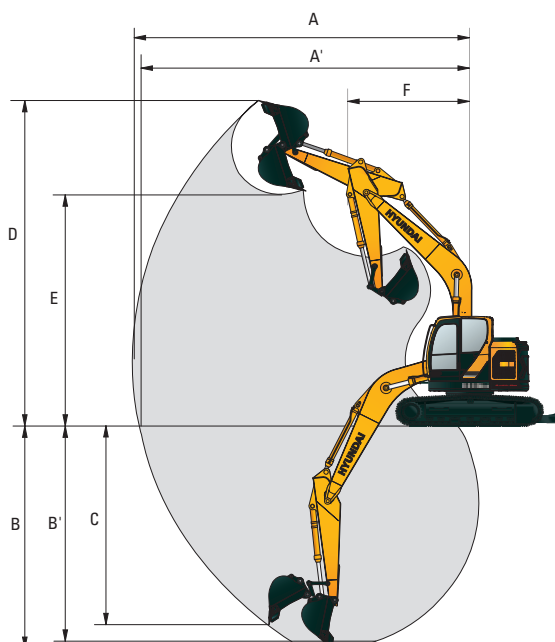

Einheit : mm (ft-in)

Auslegerlänge	5680 (18' 8")		
Löffelstiellänge	2000 (6' 7")	2400 (7' 10")	2920 (9' 7")
A Max. Schachtweite	9040 (29' 8")	9430 (30' 11")	9910 (32' 6")
A' Max. Schachtweite am Boden	8860 (29' 1")	9260 (30' 5")	9750 (32' 0")
B Max. Schachttiefe	5780 (19' 0")	6180 (20' 3")	6700 (22' 0")
B' Max. Schachttiefe (auf ca. 2,40 m)	5550 (18' 3")	5980 (19' 7")	6530 (21' 5")
C Max. vertikale Abstechtiefe	5140 (16' 10")	5710 (18' 9")	6270 (20' 7")
D Max. Einstechhöhe	10090 (33' 1")	10420 (34' 2")	10830 (35' 6")
E Max. Ladehöhe	7190 (23' 7")	7510 (24' 8")	7890 (25' 11")
F Min. Frontschwenkradius	2860 (9' 5")	2550 (8' 4")	2350 (7' 9")

MASSE UND ARBEITSBEREICH

HX235 LCR

ABMESSUNGEN HX235 LCR ZWEITEILIGER AUSLEGER

Zweiteiliger Ausleger in 5,65 m (18' 6") und Löffelstiel in 2,0 m (6' 7"); 2,4 m (7' 10") und 2,92 m (9' 7").

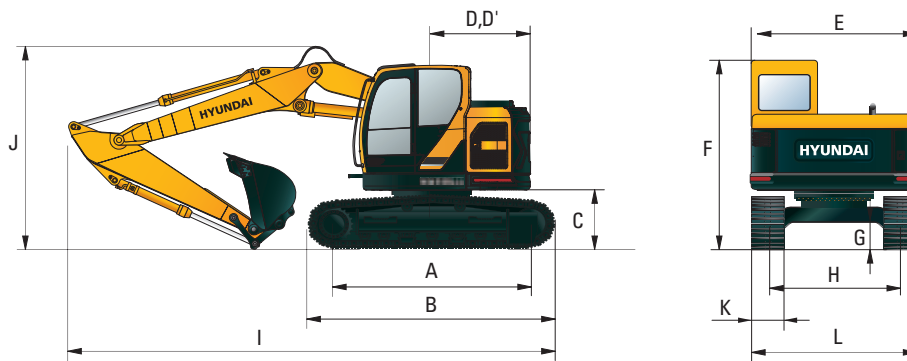

Einheit : mm (ft-in)

A	Aufstandslänge	3650 (12' 0")
B	Gesamtlänge der Raupe	4404 (14' 6")
C	Bodenfreiheit des Heckgegengewichts	1080 (3' 7")
D	Heckschwenkradius	1780 (6' 04")
D'	Hecklänge	1780 (6' 04")
E	Gesamtbreite des Oberwagens	2980 (9' 9")
F	Gesamthöhe der Kabine	3290 (10' 10")
G	Mindest-Bodenfreiheit	480 (1' 7")
H	Spurweite	2390 (7' 10")

Auslegerlänge	5650 (18' 6") Zweiteiliger Ausleger			
Löffelstiellänge	2000 (6' 7")	2400 (7' 10")	2920 (9' 7")	
I Gesamtlänge	9000 (29' 6")	8910 (29' 3")	8900 (29' 2")	
J Gesamthöhe des Auslegers	3050 (10' 0")	3000 (9' 10")	2990 (9' 10")	
K Breite der Bodenplatten	600 (24")	700 (28")	800 (32")	900 (36")
L Gesamtbreite	2990 (9' 10")	3090 (10' 2")	3190 (10' 6")	3290 (10' 10")

ARBEITSBEREICH HX235 LCR ZWEITEILIGER AUSLEGER

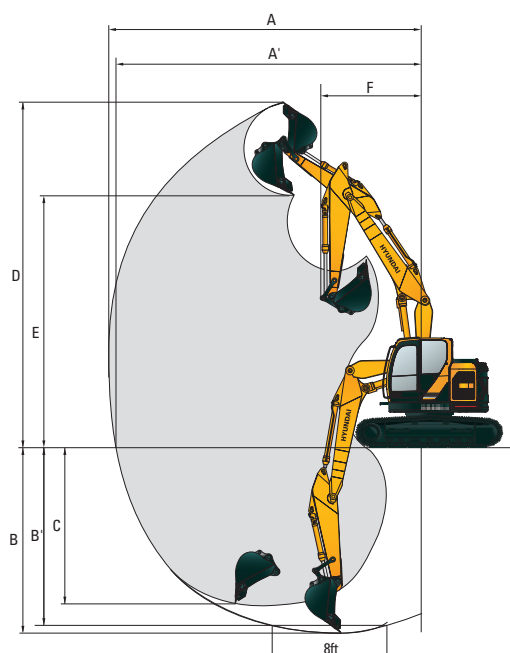

Einheit : mm (ft-in)

Auslegerlänge	5650 (18' 6") Zweiteiliger Ausleger		
Löffelstiellänge	2000 (6' 7")	2400 (7' 10")	2920 (9' 7")
A Max. Schachtweite	9050 (29' 8")	9460 (31' 0")	10020 (32' 10")
A' Max. Schachtweite am Boden	8880 (29' 2")	9290 (30' 6")	9860 (32' 4")
B Max. Schachttiefe	5460 (17' 11")	5860 (19' 3")	6380 (20' 11")
B' Max. Schachttiefe (auf ca. 2,40 m)	5340 (17' 6")	5750 (18' 10")	6270 (20' 7")
C Max. vertikale Abstechtiefte	4530 (14' 10")	4970 (16' 4")	5520 (18' 1")
D Max. Einstechhöhe	10600 (34' 9")	10990 (36' 1")	11470 (37' 8")
E Max. Ladehöhe	7680 (25' 2")	8090 (26' 7")	8540 (28' 0")
F Min. Frontschwenkradius	2130 (7' 0")	2030 (6' 8")	2000 (6' 7")

MASSE UND ARBEITSBEREICH

HX235 LCR

ABMESSUNGEN HX235 LCR ZWEIFTEILIGER AUSLEGER (MIT PLANIERSCHILD)

Zweiteiliger Ausleger in 5,65 m (18' 6") und Löffelstiel in 2,0 m (6' 7"); 2,4 m (7' 10") und 2,92 m (9' 7").

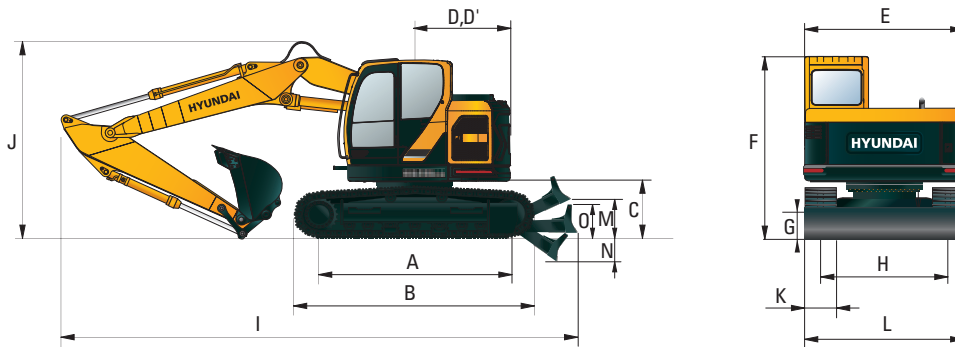

Einheit : mm (ft-in)

A	Aufstandslänge	3650 (12' 0")
B	Gesamtlänge der Raupe	4404 (14' 6")
C	Bodenfreiheit des Heckgegengewichts	1080 (3' 7")
D	Heckschwenkradius	1780 (6' 04")
D'	Hecklänge	1780 (6' 04")
E	Gesamtbreite des Oberwagens	2980 (9' 9")
F	Gesamthöhe der Kabine	3290 (10' 10")
G	Mindest-Bodenfreiheit	480 (1' 7")
H	Spurweite	2390 (7' 10")
M	Bodenfreiheit mit gehobenem Planierschild	550 (1' 10")
N	Tiefe mit abgesenktem Planierschild	410 (1' 4")
O	Höhe des Planierschildes	740 (2' 5")

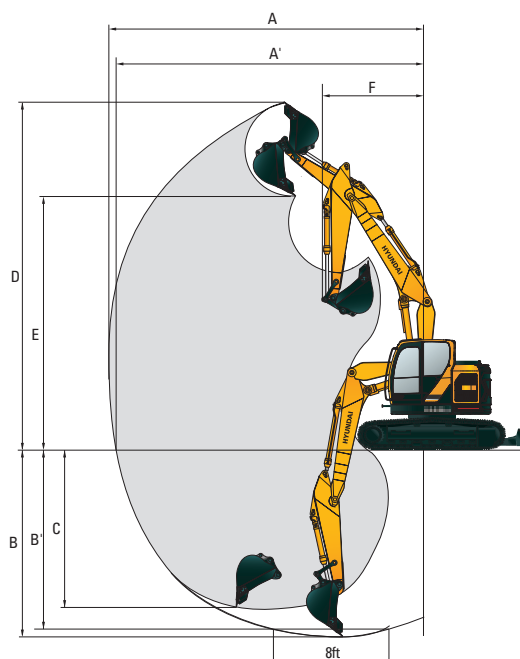

Auslegerlänge	5650 (18' 6") Zweiteiliger Ausleger			
Löffelstiellänge	2000 (6' 7")	2400 (7' 10")	2920 (9' 7")	
I Gesamtlänge	9850 (32' 4")	9760 (32' 0")	9750 (32' 0")	
J Gesamthöhe des Auslegers	3050 (10' 0")	3000 (9' 10")	2990 (9' 10")	
K Breite der Bodenplatten	600 (24")	700 (28")	800 (32")	900 (36")
L Gesamtbreite	2990 (9' 10")	3090 (10' 2")	3190 (10' 6")	3290 (10' 10")

ARBEITSBEREICH HX235 LCR ZWEIFTEILIGER AUSLEGER (MIT PLANIERSCHILD)













Einheit : mm (ft-in)

Auslegerlänge	5650 (18' 6") Zweiteiliger Ausleger		
Löffelstiellänge	2000 (6' 7")	2400 (7' 10")	2920 (9' 7")
A Max. Schachtweite	9050 (29' 8")	9460 (31' 0")	10020 (32' 10")
A' Max. Schachtweite am Boden	8880 (29' 2")	9290 (30' 6")	9860 (32' 4")
B Max. Schachttiefe	5460 (17' 11")	5860 (19' 3")	6380 (20' 11")
B' Max. Schachttiefe (auf ca. 2,40 m)	5340 (17' 6")	5750 (18' 10")	6270 (20' 7")
C Max. vertikale Abstechtiefte	4530 (14' 10")	4970 (16' 4")	5520 (18' 1")
D Max. Einstechhöhe	10600 (34' 9")	10990 (36' 1")	11470 (37' 8")
E Max. Ladehöhe	7680 (25' 2")	8090 (26' 7")	8540 (28' 0")
F Min. Frontschwenkradius	2130 (7' 0")	2030 (6' 8")	2000 (6' 7")











 Lastradius Frontauslage  Lastradius Seitenauslage bzw. 360 Grad

HX235 LCR MONO AUSLEGER

Ausleger: 5,68 m (18' 8") / Löffelstiel: 2,0 m (6' 7") / Tieflöffel: 0,80 m³ (1.05 yd³) SAE gehäuft / 600 mm (24") 3-Step-Bodenplatten.



Lasthöhe m (ft)		Lastradius								Max. Reichweite		
		3.0 m (10 ft)		4.5 m (15 ft)		6.0 m (20 ft)		7.5 m (25 ft)		Volumen		Reichweite m (ft)
												
10.5 m (35 ft)	kg									*4160	*4160	4.63
	lb									*9170	*9170	(15.2)
9.0 m (30 ft)	kg									*4580	*4580	4.48
	lb									*10100	*10100	(14.7)
7.5 m (25 ft)	kg		*4770	*4770						*4100	*4100	6.56
	lb		*10520	*10520						*9040	*9040	(21.5)
6.0 m (20 ft)	kg		*4930	*4930	*4540	*4540				*3990	3080	7.70
	lb		*10870	*10870	*10010	*10010				*8800	6790	(25.3)
4.5 m (15 ft)	kg	*8300	*8300	*5880	*5880	*4860	4630			*3990	2580	8.36
	lb	*18300	*18300	*12960	*12960	*10710	10210			*8800	5690	(27.4)
3.0 m (10 ft)	kg		*7250	6860	*5440	4370	*4570	3000		*4030	2340	8.67
	lb		*15980	15120	*11990	9630	*10080	6610		*8880	5160	(28.4)
1.5 m (5 ft)	kg		*8350	6350	*5980	4120	*4770	2890		*4080	2290	8.66
	lb		*18410	14000	*13180	9080	*10520	6370		*8990	5050	(28.4)
Boden-niveau	kg		*8660	6110	*6250	3960				*4100	2410	8.36
	lb		*19090	13470	*13780	8730				*9040	5310	(27.4)
-1.5 m (-5 ft)	kg	*11410	*11410	*8260	6080	*6050	3910			*4010	2790	7.69
	lb	*25150	*25150	*18210	13400	*13340	8620			*8840	6150	(25.2)
-3.0 m (-10 ft)	kg	*9650	*9650	*7130	6190	*5090	4000			*3610	*3610	6.55
	lb	*21270	*21270	*15720	13650	*11220	8820			*7960	*7960	(21.5)

Ausleger: 5,68 m (18' 8") / Löffelstiel: 2,4 m (7' 10") / Tieflöffel: 0,80 m³ (1.05 yd³) SAE gehäuft / 600 mm (24") 3-Step-Bodenplatten.

Lasthöhe m (ft)		Lastradius								Max. Reichweite				
		1.5 m (5 ft)		3.0 m (10 ft)		4.5 m (15 ft)		6.0 m (20 ft)		7.5 m (25 ft)		Volumen		Reichweite m (ft)
														
9.0 m (30 ft)	kg											*4060	*4060	5.25
	lb											*8950	*8950	(17.2)
7.5 m (25 ft)	kg					*4230	*4230					*3770	3710	7.07
	lb					*9330	*9330					*8310	8180	(23.2)
6.0 m (20 ft)	kg					*4450	*4450	*4170	*4170			*3700	2800	8.12
	lb					*9810	*9810	*9190	*9190			*8160	6170	(26.6)
4.5 m (15 ft)	kg		*7210	*7210	*5400	*5400	*4550	*4550	*3900	3120		*3720	2370	8.74
	lb		*15900	*15900	*11900	*11900	*10030	*10030	*8600	6880		*8200	5220	(28.7)
3.0 m (10 ft)	kg		*11320	*11320	*6790	*6790	*5170	4410	*4360	3010		*3770	2160	9.04
	lb		*24960	*24960	*14970	*14970	*11400	9720	*9610	6640		*8310	4760	(29.7)
1.5 m (5 ft)	kg				*8040	6400	*5790	4130	*4630	2880		*3830	2110	9.03
	lb				*17730	14110	*12760	9110	*10210	6350		*8440	4650	(29.6)
Boden-niveau	kg		*9170	*9170	*8580	6100	*6150	3940	*4760	2780		*3870	2210	8.74
	lb		*20220	*20220	*18920	13450	*13560	8690	*10490	6130		*8530	4870	(28.7)
-1.5 m (-5 ft)	kg	*9770	*9770	*12150	12070	*8390	6010	*6100	3860			*3840	2510	8.12
	lb	*21540	*21540	*26790	26610	*18500	13250	*13450	8510			*8470	5530	(26.6)
-3.0 m (-10 ft)	kg	*14230	*14230	*10480	*10480	*7490	6080	*5420	3900			*3600	3230	7.06
	lb	*31370	*31370	*23100	*23100	*16510	13400	*11950	8600			*7940	7120	(23.2)
-4.5 m (-15 ft)	kg		*7610	*7610	*5470	*5470								
	lb		*16780	*16780	*12060	*12060								













- Die Hublast richtet sich nach der Definition in SAE J1097 und ISO 10567.
- Die Hublast der Serie ROBEX darf auf festem, ebenem Untergrund maximal 75 % der Kipplast der Maschine bzw. 87 % der gesamten hydraulischen Hubkraft betragen.

- Der Lastpunkt ist ein Haken (Standardausrüstung) an der Rückseite des Tieflöffels.
- (*) gibt die Lastbegrenzung durch die hydraulische Hubkraft an.











 Lastradius Frontauslage  Lastradius Seitenauslage bzw. 360 Grad

HX235 LCR MONO AUSLEGER

Ausleger: 5,68 m (18' 8") / Löffelstiel: 2,92 m (9' 7") / Tieföffel: 0,80 m³ (1.05 yd³) SAE gehäuft / 600 mm (24") 3-Steg-Bodenplatten.



Lasthöhe m (ft)	Lastradius										Max. Reichweite			
	1.5 m (5 ft)		3.0 m (10 ft)		4.5 m (15 ft)		6.0 m (20 ft)		7.5 m (25 ft)		Volumen		Reichweite	
													m (ft)	
9.0 m (30 ft)	kg				*2920	*2920					*3570	*3570	6.12	
	lb				*6440	*6440					*7870	*7870	(20.1)	
7.5 m (25 ft)	kg						*3260	*3260			*3410	3210	7.70	
	lb						*7190	*7190			*7520	7080	(25.3)	
6.0 m (20 ft)	kg						*3720	*3720			*3380	2500	8.66	
	lb						*8200	*8200			*7450	5510	(28.4)	
4.5 m (15 ft)	kg				*4750	*4750	*4140	*4140	*3800	3170	*3410	2130	9.24	
	lb				*10470	*10470	*9130	*9130	*8380	6990	*7520	4700	(30.3)	
3.0 m (10 ft)	kg		*9680	*9680	*6180	*6180	*4810	4460	*4100	3030	*3460	1950	9.52	
	lb		*21340	*21340	*13620	*13620	*10600	9830	*9040	6680	*7630	4300	(31.2)	
1.5 m (5 ft)	kg		*9550	*9550	*7590	6510	*5500	4160	*4440	2880	*3530	1900	9.52	
	lb		*21050	*21050	*16730	14350	*12130	9170	*9790	6350	*7780	4190	(31.2)	
Boden- niveau	kg		*9930	*9930	*8400	6110	*5990	3930	*4670	2760	*3600	1970	9.24	
	lb		*21890	*21890	*18520	13470	*13210	8660	*10300	6080	*7940	4340	(30.3)	
-1.5 m (-5 ft)	kg	*8850	*8850	*12790	11890	*8470	5950	*6100	3810	*4630	2690	*3620	2210	8.66
	lb	*19510	*19510	*28200	26210	*18670	13120	*13450	8400	10210	5930	*7980	4870	(28.4)
-3.0 m (-10 ft)	kg	*12280	*12280	*11380	*11380	*7840	5960	*5690	3810			*3500	2750	7.69
	lb	*27070	*27070	*25090	*25090	*17280	13140	*12540	8400			*7720	6060	(25.2)
-4.5 m (-15 ft)	kg			*8920	*8920	*6300	6140					*2930	*2930	6.11
	lb			*19670	*19670	*13890	13540					*6460	*6460	(20.0)

Ausleger: 5,68 m (18' 8") / Löffelstiel: 2,0 m (7' 10") / Tieföffel: 0,80 m³ (1.05 yd³) SAE gehäuft / 600 mm (24") 3-Steg-Bodenplatten. Planierschild gehoben

Lasthöhe m (ft)	Lastradius								Max. Reichweite			
	3.0 m (10 ft)		4.5 m (15 ft)		6.0 m (20 ft)		7.5 m (25 ft)		Volumen		Reichweite	
											m (ft)	
10.5 m (35 ft)	kg									*4160	*4160	4.63
	lb									*9170	*9170	(15.2)
9.0 m (30 ft)	kg									*4580	*4580	4.48
	lb									*10100	*10100	(14.7)
7.5 m (25 ft)	kg			*4770	*4770					*4100	*4100	6.56
	lb			*10520	*10520					*9040	*9040	(21.5)
6.0 m (20 ft)	kg			*4930	*4930	*4540	*4540			*3990	3520	7.70
	lb			*10870	*10870	*10010	*10010			*8800	7760	(25.3)
4.5 m (15 ft)	kg	*8300	*8300	*5880	*5880	*4860	*4860			*3990	2960	8.36
	lb	*18300	*18300	*12960	*12960	*10710	*10710			*8800	6530	(27.4)
3.0 m (10 ft)	kg			*7250	*7250	*5440	4980	*4570	3440	*4030	2710	8.67
	lb			*15980	*15980	*11990	10980	*10080	7580	*8880	5970	(28.4)
1.5 m (5 ft)	kg			*8350	7280	*5980	4730	*4770	3330	*4080	2660	8.66
	lb			*18410	16050	*13180	10430	*10520	7340	*8990	5860	(28.4)
Boden- niveau	kg			*8660	7040	*6250	4560			*4100	2800	8.36
	lb			*19090	15520	*13780	10050			*9040	6170	(27.4)
-1.5 m (-5 ft)	kg	*11410	*11410	*8260	7010	*6050	4510			*4010	3220	7.69
	lb	*25150	*25150	*18210	15450	*13340	9940			*8840	7100	(25.2)
-3.0 m (-10 ft)	kg	*9650	*9650	*7130	7130	*5090	4610			*3610	*3610	6.55
	lb	*21270	*21270	*15720	15720	*11220	10160			*7960	*7960	(21.5)











- Die Hublast richtet sich nach der Definition in SAE J1097 und ISO 10567.
- Die Hublast der Serie ROBEX darf auf festem, ebenem Untergrund maximal 75 % der Kipplast der Maschine bzw. 87 % der gesamten hydraulischen Hubkraft betragen.

- Der Lastpunkt ist ein Haken (Standardausrüstung) an der Rückseite des Tieföffels.
- (*) gibt die Lastbegrenzung durch die hydraulische Hubkraft an.













 Lastradius Frontauslage  Lastradius Seitenauslage bzw. 360 Grad

HX235 LCR MONO AUSLEGER

Ausleger: 5,68 m (18' 8") / Löffelstiel: 2,0 m (6' 7") / Tieflöffel: 0,80 m³ (1.05 yd³) SAE gehäuft / 600 mm (24") 3-Stege-Bodenplatten. Planierschild abgesenkt



Lasthöhe m (ft)	Lastradius								Max. Reichweite		
	3.0 m (10 ft)		4.5 m (15 ft)		6.0 m (20 ft)		7.5 m (25 ft)		Volumen	Reichweite	
											m (ft)
10.5 m (35 ft)	kg								*4160	*4160	4.63
	lb								*9170	*9170	(15.2)
9.0 m (30 ft)	kg								*4580	*4580	4.48
	lb								*10100	*10100	(14.7)
7.5 m (25 ft)	kg		*4770	*4770					*4100	*4100	6.56
	lb		*10520	*10520					*9040	*9040	(21.5)
6.0 m (20 ft)	kg		*4930	*4930	*4540	*4540			*3990	3300	7.70
	lb		*10870	*10870	*10010	*10010			*8800	7280	(25.3)
4.5 m (15 ft)	kg	*8300	*8300	*5880	*5880	*4860	*4860		*3990	2770	8.36
	lb	*18300	*18300	*12960	*12960	*10710	*10710		*8800	6110	(27.4)
3.0 m (10 ft)	kg		*7250	*7250	*5440	4660	*4570	3220	*4030	2530	8.67
	lb		*15980	*15980	*11990	10270	*10080	7100	*8880	5580	(28.4)
1.5 m (5 ft)	kg		*8350	6770	*5980	4410	*4770	3110	*4080	2480	8.66
	lb		*18410	14930	*13180	9720	*10520	6860	*8990	5470	(28.4)
Boden- niveau	kg		*8660	6530	*6250	4250			*4100	2610	8.36
	lb		*19090	14400	*13780	9370			*9040	5750	(27.4)
-1.5 m (-5 ft)	kg	*11410	*11410	*8260	6500	*6050	4200		*4010	3000	7.69
	lb	*25150	*25150	*18210	14330	*13340	9260		*8840	6610	(25.2)
-3.0 m (-10 ft)	kg	*9650	*9650	*7130	6610	*5090	4290		*3610	*3610	6.55
	lb	*21270	*21270	*15720	14570	*11220	9460		*7960	*7960	(21.5)

Ausleger: 5,68 m (18' 8") / Löffelstiel: 2,4 m (7' 10") / Tieflöffel: 0,80 m³ (1.05 yd³) SAE gehäuft / 600 mm (24") 3-Stege-Bodenplatten. Planierschild gehoben

Lasthöhe m (ft)	Lastradius								Max. Reichweite				
	1.5 m (5 ft)		3.0 m (10 ft)		4.5 m (15 ft)		6.0 m (20 ft)		7.5 m (25 ft)		Volumen	Reichweite	
													m (ft)
9.0 m (30 ft)	kg										*4060	*4060	5.25
	lb										*8950	*8950	(17.2)
7.5 m (25 ft)	kg					*4230	*4230				*3770	*3770	7.07
	lb					*9330	*9330				*8310	*8310	(23.2)
6.0 m (20 ft)	kg					*4450	*4450	*4170	*4170		*3700	3210	8.12
	lb					*9810	*9810	*9190	*9190		*8160	7080	(26.6)
4.5 m (15 ft)	kg		*7210	*7210	*5400	*5400	*4550	*4550	*3900	3560	*3720	2730	8.74
	lb		*15900	*15900	*11900	*11900	*10030	*10030	*8600	7850	*8200	6020	(28.7)
3.0 m (10 ft)	kg		*11320	*11320	*6790	*6790	*5170	5020	*4360	3450	*3770	2510	9.04
	lb		*24960	*24960	*14970	*14970	*11400	11070	*9610	7610	*8310	5530	(29.7)
1.5 m (5 ft)	kg				*8040	7340	*5790	4740	*4630	3320	*3830	2460	9.03
	lb				*17730	16180	*12760	10450	*10210	7320	*8440	5420	(29.6)
Boden- niveau	kg		*9170	*9170	*8580	7030	*6150	4540	*4760	3230	*3870	2570	8.74
	lb		*20220	*20220	*18920	15500	*13560	10010	*10490	7120	*8530	5670	(28.7)
-1.5 m (-5 ft)	kg	*9770	*9770	*12150	*12150	*8390	6940	*6100	4460		*3840	2920	8.12
	lb	*21450	*21450	*26790	*26790	*18500	15300	*13450	9830		*8470	6440	(26.6)
-3.0 m (-10 ft)	kg	*14230	*14230	*10480	*10480	*7490	7020	*5420	4510		*3600	*3600	7.06
	lb	*31370	*31370	*23100	*23100	*16510	15480	*11950	9940		*7940	*7940	(23.2)
-4.5 m (-15 ft)	kg		*7610	*7610	*5470	*5470							
	lb		*16780	*16780	*12060	*12060							













- Die Hublast richtet sich nach der Definition in SAE J1097 und ISO 10567.
- Die Hublast der Serie ROBEX darf auf festem, ebenem Untergrund maximal 75 % der Kipplast der Maschine bzw. 87 % der gesamten hydraulischen Hubkraft betragen.

- Der Lastpunkt ist ein Haken (Standardausrüstung) an der Rückseite des Tieflöffels.
- (*) gibt die Lastbegrenzung durch die hydraulische Hubkraft an.













 Lastradius Frontauslage  Lastradius Seitenauslage bzw. 360 Grad

HX235 LCR MONO AUSLEGER

Ausleger: 5,68 m (18' 8") / Löffelstiel: 2,4 m (7' 10") / Tieflöffel: 0,80 m³ (1.05 yd³) SAE gehäuft / 600 mm (24") 3-Steg-Bodenplatten. Planierschild abgesenkt



Lasthöhe m (ft)	Lastradius										Max. Reichweite			
	1.5 m (5 ft)		3.0 m (10 ft)		4.5 m (15 ft)		6.0 m (20 ft)		7.5 m (25 ft)		Volumen	Reichweite		
													m (ft)	
9.0 m (30 ft)	kg											*4060	*4060	5.25
	lb											*8950	*8950	(17.2)
7.5 m (25 ft)	kg				*4230	*4230						*3770	*3770	7.07
	lb				*9330	*9330						*8310	*8310	(23.2)
6.0 m (20 ft)	kg				*4450	*4450	*4170	*4170				*3700	3000	8.12
	lb				*9810	*9810	*9190	*9190				*8160	6610	(26.6)
4.5 m (15 ft)	kg		*7210	*7210	*5400	*5400	*4550	*4550	*3900	3340		*3720	2550	8.74
	lb		*15900	*15900	*11900	*11900	*10030	*10030	*8600	7360		*8200	5620	(28.7)
3.0 m (10 ft)	kg		*11320	*11320	*6790	*6790	*5170	4700	*4360	3230		*3770	2340	9.04
	lb		*24960	*24960	*14970	*14970	*11400	10360	*9610	7120		*8310	5160	(29.7)
1.5 m (5 ft)	kg				*8040	6830	*5790	4420	*4630	3100		*3830	2280	9.03
	lb				*17730	15060	*12760	9740	*10210	6830		*8440	5030	(29.6)
Boden- niveau	kg		*9170	*9170	*8580	6520	*6150	4230	*4760	3000		*3870	2390	8.74
	lb		*20220	*20220	*18920	14370	*13560	9330	*10490	6610		*8530	5270	(28.7)
-1.5 m (-5 ft)	kg	*9770	*9770	*12150	12070	*8390	6440	*6100	4150			*3840	2710	8.12
	lb	*21540	*21540	*26790	26610	*18500	14200	*13450	9150			*8470	5970	(26.6)
-3.0 m (-10 ft)	kg	*14230	*14230	*10480	*10480	*7490	6510	*5420	4190			*3600	3470	7.06
	lb	*31370	*31370	*23100	*23100	*16510	14350	*11950	9240			*7940	7650	(23.2)
-4.5 m (-15 ft)	kg		*7610	*7610	*5470	*5470								
	lb		*16780	*16780	*12060	*12060								

Ausleger: 5,68 m (18' 8") / Löffelstiel: 2,92 m (9' 7") / Tieflöffel: 0,80 m³ (1.05 yd³) SAE gehäuft / 600 mm (24") 3-Steg-Bodenplatten. Planierschild gehoben

Lasthöhe m (ft)	Lastradius										Max. Reichweite			
	1.5 m (5 ft)		3.0 m (10 ft)		4.5 m (15 ft)		6.0 m (20 ft)		7.5 m (25 ft)		Volumen	Reichweite		
													m (ft)	
9.0 m (30 ft)	kg				*2920	*2920						*3570	*3570	6.12
	lb				*6440	*6440						*7870	*7870	(20.1)
7.5 m (25 ft)	kg						*3260	*3260				*3410	*3410	7.70
	lb						*7190	*7190				*7520	*7520	(25.3)
6.0 m (20 ft)	kg						*3720	*3720				*3380	2870	8.66
	lb						*8200	*8200				*7450	6330	(28.4)
4.5 m (15 ft)	kg				*4750	*4750	*4140	*4140	*3800	3620		*3410	2470	9.24
	lb				*10470	*10470	*9130	*9130	*8380	7980		*7520	5450	(30.3)
3.0 m (10 ft)	kg		*9680	*9680	*6180	*6180	*4810	*4810	*4100	3480		*3460	2280	9.52
	lb		*21340	*21340	*13620	*13620	*10600	*10600	*9040	7670		*7630	5030	(31.2)
1.5 m (5 ft)	kg		*9550	*9550	*7590	7450	*5500	4770	*4440	3330		*3530	2230	9.52
	lb		*21050	*21050	*16730	16420	*12130	10520	*9790	7340		*7780	4920	(31.2)
Boden- niveau	kg		*9930	*9930	*8400	7040	*5990	4530	*4670	3200		*3600	2310	9.24
	lb		*21890	*21890	*18520	15520	*13210	9990	*10300	7050		*7940	5090	(30.3)
-1.5 m (-5 ft)	kg	*8850	*8850	*12790	11890	*8470	6880	*6100	4410	*4630	3140	*3620	2580	8.66
	lb	*19510	*19510	*28200	26210	*18670	15170	*13450	9720	*10210	6920	*7980	5690	(28.4)
-3.0 m (-10 ft)	kg	*12280	*12280	*11380	*11380	*7840	6900	*5690	4410			*3500	3180	7.69
	lb	*27070	*27070	*25090	*25090	*17280	15210	*12540	9720			*7720	7010	(25.2)
-4.5 m (-15 ft)	kg		*8920	*8920	*6300	*6300						*2930	*2930	6.11
	lb		*19670	*19670	*13890	*13890						*6460	*6460	(20.0)













1. Die Hublast richtet sich nach der Definition in SAE J1097 und ISO 10567.
2. Die Hublast der Serie ROBEX darf auf festem, ebenem Untergrund maximal 75 % der Kipplast der Maschine bzw. 87 % der gesamten hydraulischen Hubkraft betragen.

3. Der Lastpunkt ist ein Haken (Standardausrüstung) an der Rückseite des Tieflöffels.
4. (*) gibt die Lastbegrenzung durch die hydraulische Hubkraft an.

 Lastradius Frontauslage  Lastradius Seitenauslage bzw. 360 Grad











HX235 LCR MONO AUSLEGER

Ausleger: 5,68 m (18' 8") / Löffelstiel: 2,92 m (9' 7") / Tieflöffel: 0,80 m³ (1.05 yd³) SAE gehäuft / 600 mm (24") 3-Steg-Bodenplatten. Planierschild abgesenkt



Lasthöhe m (ft)	Lastradius										Max. Reichweite			
	1.5 m (5 ft)		3.0 m (10 ft)		4.5 m (15 ft)		6.0 m (20 ft)		7.5 m (25 ft)		Volumen		Reichweite m (ft)	
														
9.0 m (30 ft)	kg				*2920	*2920					*3570	*3570	6.12	
	lb				*6440	*6440					*7870	*7870	(20.1)	
7.5 m (25 ft)	kg						*3260	*3260			*3410	*3410	7.70	
	lb						*7190	*7190			*7520	*7520	(25.3)	
6.0 m (20 ft)	kg						*3720	*3720			*3380	2680	8.66	
	lb						*8200	*8200			*7450	5910	(28.4)	
4.5 m (15 ft)	kg				*4750	*4750	*4140	*4140	*3800	3390	*3410	2300	9.24	
	lb				*10470	*10470	*9130	*9130	*8380	7470	*7520	5070	(30.3)	
3.0 m (10 ft)	kg		*9680	*9680	*6180	*6180	*4810	4750	*4100	3250	*3460	2120	9.52	
	lb		*21340	*21340	*13620	*13620	*10600	10470	*9040	7170	*7630	4670	(31.2)	
1.5 m (5 ft)	kg		*9550	*9550	*7590	6930	*5500	4450	*4440	3100	*3530	2070	9.52	
	lb		*21050	*21050	*16730	15280	*12130	9810	*9790	6830	*7780	4560	(31.2)	
Boden-niveau	kg		*9930	*9930	*8400	6530	*5990	4220	*4670	2980	*3600	2150	9.24	
	lb		*21890	*21890	*18520	14400	*13210	9300	*10300	6570	*7940	4740	(30.3)	
-1.5 m (-5 ft)	kg	*8850	*8850	*12790	12690	*8470	6370	*6100	4100	*4630	2910	*3620	2400	8.66
	lb	*19510	*19510	*28200	27980	*18670	14040	*13450	9040	*10210	6420	*7980	5290	(28.4)
-3.0 m (-10 ft)	kg	*12280	*12280	*11380	*11380	*7840	6390	*5690	4100			*3500	2960	7.69
	lb	*27070	*27070	*25090	*25090	*17280	14090	*12540	9040			*7720	6530	(25.2)
-4.5 m (-15 ft)	kg			*8920	*8920	*6300	*6300					*2930	*2930	6.11
	lb			*19670	*19670	*13890	*13890					*6460	*6460	(20.0)

HX235 LCR ZWEITEILIGER AUSLEGER

Ausleger: 5,65 m (18' 6") / Löffelstiel: 2,0 m (6' 7") / Tieflöffel: 0,80 m³ (1.05 yd³) SAE gehäuft / 600 mm (24") 3-Steg-Bodenplatten. Planierschild gehoben











Lasthöhe m (ft)	Lastradius										Max. Reichweite		
	3.0 m (10 ft)		4.5 m (15 ft)		6.0 m (20 ft)		7.5 m (25 ft)		Volumen		Reichweite m (ft)		
													
9.0 m (30 ft)	kg										*6750	*6750	4.51
	lb										*14880	*14880	(14.8)
7.5 m (25 ft)	kg	*8110	*8110	*6850	*6850						*5200	4700	6.58
	lb	*17880	*17880	*15100	*15100						*11460	10360	(21.6)
6.0 m (20 ft)	kg	*8460	*8460	*6960	*6960	*5740	5390				*4630	3470	7.72
	lb	*18650	*18650	*15340	*15340	*12650	11880				*10210	7650	(25.3)
4.5 m (15 ft)	kg	*11210	*11210	*7620	*7620	*5920	5230				*4270	2920	8.37
	lb	*24710	*24710	*16800	*16800	*13050	11530				*9410	6440	(27.5)
3.0 m (10 ft)	kg			*8430	7790	*6190	4950	*4850	3410		*3960	2670	8.68
	lb			*18580	17170	*13650	10910	*10690	7520		*8730	5890	(28.5)
1.5 m (5 ft)	kg			*8660	7230	*6260	4690	*4710	3300		*3610	2620	8.68
	lb			*19090	15940	*13800	10340	*10380	7280		*7960	5780	(28.5)
Boden-niveau	kg			*7950	6980	*5880	4520	*4200	3230		*3130	2770	8.37
	lb			*17530	15390	*12960	9960	*9260	7120		*6900	6110	(27.5)
-1.5 m (-5 ft)	kg	*7060	*7060	*6470	*6470	*4870	4480				*2330	*2330	7.71
	lb	*15560	*15560	*14260	*14260	*10740	9880				*5140	*5140	(25.3)
-3.0 m (-10 ft)	kg			*4140	*4140	*2800	*2800						
	lb			*9130	*9130	*6170	*6170						

- Die Hublast richtet sich nach der Definition in SAE J1097 und ISO 10567.
- Die Hublast der Serie ROBEX darf auf festem, ebenem Untergrund maximal 75 % der Kipplast der Maschine bzw. 87 % der gesamten hydraulischen Hubkraft betragen.
- Der Lastpunkt ist ein Haken (Standardausrüstung) an der Rückseite des Tieflöffels.
- (*) gibt die Lastbegrenzung durch die hydraulische Hubkraft an.











 Lastradius Frontauslage  Lastradius Seitenauslage bzw. 360 Grad

HX235 LCR ZWEITEILIGER AUSLEGER

Ausleger: 5,65 m (18' 6") / Löffelstiel: 2,0 m (6' 7") / Tieflöffel: 0,80 m³ (1.05 yd³) SAE gehäuft / 600 mm (24") 3-Stege-Bodenplatten. Planierschild abgesenkt



Lasthöhe m (ft)	Lastradius								Max. Reichweite			
	3.0 m (10 ft)		4.5 m (15 ft)		6.0 m (20 ft)		7.5 m (25 ft)		Volumen	Reichweite		
											m (ft)	
9.0 m (30 ft)	kg								*6750	*6750	4.51	
	lb								*14880	*14880	(14.8)	
7.5 m (25 ft)	kg	*8110	*8110	*6850	*6850				*5200	4420	6.58	
	lb	*17880	*17880	*15100	*15100				*11460	9740	(21.6)	
6.0 m (20 ft)	kg	*8460	*8460	*6960	*6960	*5740	5060		*4630	3250	7.72	
	lb	*18650	*18650	*15340	*15340	*12650	11160		*10210	7170	(25.3)	
4.5 m (15 ft)	kg	*11210	*11210	*7620	*7620	*5920	4900		*4270	2720	8.37	
	lb	*24710	*24710	*16800	*16800	*13050	10800		*9410	6000	(27.5)	
3.0 m (10 ft)	kg			*8430	7250	*6190	4630	*4850	3180	*3960	2480	8.68
	lb			*18580	15980	*13650	10210	*10690	7010	*8730	5470	(28.5)
1.5 m (5 ft)	kg			*8660	6710	*6260	4370	*4710	3070	*3610	2440	8.68
	lb			*19090	14790	*13800	9630	*10380	6770	*7960	5380	(28.5)
Boden-niveau	kg			*7950	6460	*5880	4200	*4200	3000	*3130	2580	8.37
	lb			*17530	14240	*12960	9260	*9260	6610	*6900	5690	(27.5)
-1.5 m (-5 ft)	kg	*7060	*7060	*6470	6450	*4870	4160		*2330	*2330	7.71	
	lb	*15560	*15560	*14260	14220	*10740	9170		*5140	*5140	(25.3)	
-3.0 m (-10 ft)	kg			*4140	*4140	*2800	*2800					
	lb			*9130	*9130	*6170	*6170					

Ausleger: 5,65 m (18' 6") / Löffelstiel: 2,4 m (7' 10") / Tieflöffel: 0,80 m³ (1.05 yd³) SAE gehäuft / 600 mm (24") 3-Stege-Bodenplatten. Planierschild gehoben

Lasthöhe m (ft)	Lastradius								Max. Reichweite			
	3.0 m (10 ft)		4.5 m (15 ft)		6.0 m (20 ft)		7.5 m (25 ft)		Volumen	Reichweite		
											m (ft)	
9.0 m (30 ft)	kg	*5600	*5600						*5830	*5830	5.31	
	lb	*12350	*12350						*12850	*12850	(17.4)	
7.5 m (25 ft)	kg	*6240	*6240	*5830	*5830				*4760	4140	7.10	
	lb	*13760	*13760	*12850	*12850				*10490	9130	(23.3)	
6.0 m (20 ft)	kg	*6390	*6390	*6570	*6570	*5480	5480		*4290	3150	8.15	
	lb	*14090	*14090	*14480	*14480	*12080	12080		*9460	6940	(26.7)	
4.5 m (15 ft)	kg	*10370	*10370	*7270	*7270	*5720	5290	*4040	3540	*3980	2690	8.77
	lb	*22860	*22860	*16030	*16030	*12610	11660	*8910	7800	*8770	5930	(28.8)
3.0 m (10 ft)	kg			*8170	7920	*6050	5000	*4790	3430	*3720	2470	9.06
	lb			*18010	17460	*13340	11020	*10560	7560	*8200	5450	(29.7)
1.5 m (5 ft)	kg			*8620	7300	*6220	4700	*4740	3290	*3420	2420	9.06
	lb			*19000	16090	*13710	10360	*10450	7250	*7540	5340	(29.7)
Boden-niveau	kg	*8940	*8940	*8190	6970	*5980	4500	*4400	3190	*3010	2540	8.77
	lb	*19710	*19710	*18060	15370	*13180	9920	*9700	7030	*6640	5600	(28.8)
-1.5 m (-5 ft)	kg	*8500	*8500	*6940	6890	*5160	4430		*2360	*2360	8.15	
	lb	*18740	*18740	*15300	15190	*11380	9770		*5200	*5200	(26.7)	
-3.0 m (-10 ft)	kg			*4860	*4860	*3490	*3490					
	lb			*10710	*10710	*7690	*7690					











- Die Hublast richtet sich nach der Definition in SAE J1097 und ISO 10567.
- Die Hublast der Serie ROBEX darf auf festem, ebenem Untergrund maximal 75 % der Kipplast der Maschine bzw. 87 % der gesamten hydraulischen Hubkraft betragen.

- Der Lastpunkt ist ein Haken (Standardausrüstung) an der Rückseite des Tieflöffels.
- (*) gibt die Lastbegrenzung durch die hydraulische Hubkraft an.











 Lastradius Frontauslage  Lastradius Seitenauslage bzw. 360 Grad

HX235 LCR

Ausleger: 5,65 m (18' 6") / Löffelstiel: 2,4 m (7' 10") / Tieflöffel: 0,80 m³ (1.05 yd³) SAE gehäuft / 600 mm (24") 3-Stege-Bodenplatten. Planierschild abgesenkt



Lasthöhe m (ft)	Lastradius								Max. Reichweite			
	3.0 m (10 ft)		4.5 m (15 ft)		6.0 m (20 ft)		7.5 m (25 ft)		Volumen	Reichweite		
											m (ft)	
9.0 m (30 ft)	kg lb	*5600 *12350	*5600 *12350						*5830 *12850	*5830 *12850	5.31 (17.4)	
7.5 m (25 ft)	kg lb	*6240 *13760	*6240 *13760	*5830 *12850	*5830 *12850				*4760 *10490	3880 8550	7.10 (23.3)	
6.0 m (20 ft)	kg lb	*6390 *14090	*6390 *14090	*6570 *14480	*6570 *14480	*5480 *12080	5140 11330		*4290 *9460	2950 6500	8.15 (26.7)	
4.5 m (15 ft)	kg lb	*10370 *22860	*10370 *22860	*7270 *16030	*7270 *16030	*5720 *12610	4960 10930	*4040 *8910	3310 7300	*3980 *8770	2500 5510	8.77 (28.8)
3.0 m (10 ft)	kg lb			*8170 *18010	7380 16270	*6050 *13340	4670 10300	*4790 *10560	3200 7050	*3720 *8200	2290 5050	9.06 (29.7)
1.5 m (5 ft)	kg lb			*8620 *19000	6770 14930	*6220 *13710	4380 9660	*4740 *10450	3060 6750	*3420 *7540	2240 4940	9.06 (29.7)
Boden- niveau	kg lb	*8940 *19710	*8940 *19710	*8190 *18060	6450 14220	*5980 *13180	4180 9220	*4400 *9700	2960 6530	*3010 *6640	2350 5180	8.77 (28.8)
-1.5 m (-5 ft)	kg lb	*8500 *18740	*8500 *18740	*6940 *15300	6370 14040	*5160 *11380	4110 9060			*2360 *5200	*2360 *5200	8.15 (26.7)
-3.0 m (-10 ft)	kg lb			*4860 *10710	*4860 *10710	*3490 *7690	*3490 *7690					

Ausleger: 5,65 m (18' 6") / Löffelstiel: 2,92 m (9' 7") / Tieflöffel: 0,80 m³ (1.05 yd³) SAE gehäuft / 600 mm (24") 3-Stege-Bodenplatten. Planierschild gehoben

Lasthöhe m (ft)	Lastradius								Max. Reichweite			
	3.0 m (10 ft)		4.5 m (15 ft)		6.0 m (20 ft)		7.5 m (25 ft)		Volumen	Reichweite		
											m (ft)	
9.0 m (30 ft)	kg lb	*4950 *10910	*4950 *10910	*3120 *6880	*3120 *6880					*4630 *10210	*4630 *10210	6.19 (20.3)
7.5 m (25 ft)	kg lb			*4750 *10470	*4750 *10470	*3400 *7500	*3400 *7500			*4050 *8930	3560 7850	7.75 (25.4)
6.0 m (20 ft)	kg lb	*4760 *10490	*4760 *10490	*5190 *11440	*5190 *11440	*4840 *10670	*4840 *10670	*2180 *4810	*2180 *4810	*3820 *8420	2800 6170	8.71 (28.6)
4.5 m (15 ft)	kg lb	*6690 *14750	*6690 *14750	*6760 *14900	*6760 *14900	*5420 *11950	5370 11840	*4250 *9370	3600 7640	*3650 *8050	2410 5310	9.29 (30.5)
3.0 m (10 ft)	kg lb	*12100 *26680	*12100 *26680	*7760 *17110	*7760 *17110	*5820 *12830	5060 11160	*4670 *10300	3450 7610	*3430 *7560	2220 4890	9.56 (31.4)
1.5 m (5 ft)	kg lb	*9380 *20680	*9380 *20680	*8470 *18670	7400 16310	*6110 *13470	4730 10430	*4710 *10380	3290 7250	*3180 *7010	2180 4810	9.56 (31.4)
Boden- niveau	kg lb	*9730 *21450	*9730 *21450	*8370 *18450	6970 15370	*6040 *13320	4480 9880	*4520 *9960	3160 6970	*2850 *6280	2270 5000	9.29 (30.5)
-1.5 m (-5 ft)	kg lb	*9980 *22000	*9980 *22000	*7420 *16360	6810 15010	*5440 *11990	4360 9610	*3890 *8580	3100 6830	*2330 *5140	*2330 *5140	8.71 (28.6)
-3.0 m (-10 ft)	kg lb	*7060 *15560	*7060 *15560	*5650 *12460	*5650 *12460	*4130 *9110	*4130 *9110					











1. Die Hublast richtet sich nach der Definition in SAE J1097 und ISO 10567.
2. Die Hublast der Serie ROBEX darf auf festem, ebenem Untergrund maximal 75 % der Kipplast der Maschine bzw. 87 % der gesamten hydraulischen Hubkraft betragen.

3. Der Lastpunkt ist ein Haken (Standardausrüstung) an der Rückseite des Tieflöffels.
4. (*) gibt die Lastbegrenzung durch die hydraulische Hubkraft an.

 Lastradius Frontauslage  Lastradius Seitenauslage bzw. 360 Grad

HX235 LCR ZWEITEILIGER AUSLEGER

Ausleger: 5,65 m (18' 6") / Löffelstiel: 2,92 m (9' 7") / Tieflöffel: 0,80 m³ (1.05 yd³) SAE gehäuft / 600 mm (24") 3-Steg-Bodenplatten. Planierschild abgesenkt

Lasthöhe m (ft)	Lastradius								Max. Reichweite		m (ft)
	3.0 m (10 ft)		4.5 m (15 ft)		6.0 m (20 ft)		7.5 m (25 ft)		Volumen		
											
9.0 m (30 ft)	kg *4950	kg *4950	kg *3120	kg *3120					kg *4630	kg *4630	6.19 (20.3)
	lb *10910	lb *10910	lb *6880	lb *6880					lb *10210	lb *10210	
7.5 m (25 ft)	kg *4750	kg *4750	kg *4750	kg *4750	kg *3400	kg *3400			kg *4050	kg 3340	7.75 (25.4)
	lb *10470	lb *10470	lb *10470	lb *10470	lb *7500	lb *7500			lb *8930	lb 7360	
6.0 m (20 ft)	kg *4760	kg *4760	kg *5190	kg *5190	kg *4840	kg *4840	kg *2180	kg *2180	kg *3820	kg 2610	8.71 (28.6)
	lb *10490	lb *10490	lb *11440	lb *11440	lb *10670	lb *10670	lb *4810	lb *4810	lb *8420	lb 5750	
4.5 m (15 ft)	kg *6690	kg *6690	kg *6760	kg *6760	kg *5420	kg 5040	kg *4250	kg 3360	kg *3650	kg 2240	9.29 (30.5)
	lb *14750	lb *14750	lb *14900	lb *14900	lb *11950	lb 11110	lb *9370	lb 7410	lb *8050	lb 4940	
3.0 m (10 ft)	kg *12100	kg *12100	kg *7760	kg 7560	kg *5820	kg 4730	kg *4670	kg 3220	kg *3430	kg 2060	9.56 (31.4)
	lb *26680	lb *26680	lb *17110	lb 16670	lb *12830	lb 10430	lb *10300	lb 7100	lb *7560	lb 4540	
1.5 m (5 ft)	kg *9380	kg *9380	kg *8470	kg 6870	kg *6110	kg 4400	kg *4710	kg 3060	kg *3180	kg 2010	9.56 (31.4)
	lb *20680	lb *20680	lb *18670	lb 15150	lb *13470	lb 9700	lb *10380	lb 6750	lb *7010	lb 4430	
Boden- niveau	kg *9730	kg *9730	kg *8370	kg 6450	kg *6040	kg 4160	kg *4520	kg 2930	kg *2850	kg 2100	9.29 (30.5)
	lb *21450	lb *21450	lb *18450	lb 14220	lb *13320	lb 9170	lb *9960	lb 6460	lb *6280	lb 4630	
-1.5 m (-5 ft)	kg *9980	kg *9980	kg *7420	kg 6290	kg *5440	kg 4040	kg *3890	kg 2870	kg *2330	kg *2330	8.71 (28.6)
	lb *22000	lb *22000	lb *16360	lb 13870	lb *11990	lb 8910	lb *8580	lb 6330	lb *5140	lb *5140	
-3.0 m (-10 ft)	kg *7060	kg *7060	kg *5650	kg *5650	kg *4130	kg 4050					
	lb *15560	lb *15560	lb *12460	lb *12460	lb *9110	lb 8930					

1. Die Hublast richtet sich nach der Definition in SAE J1097 und ISO 10567.
2. Die Hublast der Serie ROBEX darf auf festem, ebenem Untergrund maximal 75 % der Kipplast der Maschine bzw. 87 % der gesamten hydraulischen Hubkraft betragen.

3. Der Lastpunkt ist ein Haken (Standardausrüstung) an der Rückseite des Tieflöffels.
4. (*) gibt die Lastbegrenzung durch die hydraulische Hubkraft an.

MOTOR	STD	OPT
Cummins QSB 6.7 engine	●	
HYDRAULIKSYSTEM		
IPC (Intelligent Power Control)		
3 Leistungsstufen, 2 Arbeitsarten, Benutzermodus	●	
Variable Leistungssteuerung	●	
Pumpenfördermengenregelung	●	
Volumenstromregelung für Anbaugerät-Betriebsart		●
Automatischer Motorleerlauf	●	
Automatische Motorabschaltung		●
Elektronische Gebläsesteuerung	●	
KABINE UND INNENRAUM		
Kabine nach ISO-Norm		
Obenrunder Frontscheibenwischer	●	
Radio/USB-Player	●	
Mobiltelefon-Freisprecheinrichtung mit USB	●	
12-Volt-Steckdose (Wandler 24 VDC auf 12 VDC)	●	
Elektrisches Signalhorn	●	
Allwetter-Stahlkabine mit 360°-Rundsicht	●	
Sicherheitsglasscheiben	●	
Frontscheibe einschiebbar	●	
Seitenscheibe (links) als Schiebefenster	●	
Abschließbare Tür	●	
Warmhalte- und Kühlbox	●	
Aufbewahrungsfach und Aschenbecher	●	
Kabinendachabdeckung transparent	●	
Sonnenblende	●	
Tür- und Kabinenschlösser, ein Schlüssel	●	
Mechanisch gefederter, beheizter Sitz	●	
Vorsteuerdruckunterstützter Joystick	●	
Konsole höhenverstellbar	●	
Automatische Klimaregelung		
Klimaanlage und Heizung	●	
Scheibenheizung	●	
Starthilfe (Ansaugluftvorwärmung) bei kalten Temperaturen	●	
Zentrale Überwachung		
8-Zoll-LCD	●	
Motordrehzahl oder Tageszähler/Beschleunigung	●	
Motor Kühlmittel-Temperaturanzeige	●	
Max. Leistung	●	
Kriechgang/Schnellgang	●	
Automatischer Leerlauf	●	
Überlast	●	
Motor überprüfen	●	
Luftfilter verstopft	●	
Anzeigen	●	
ÖKO-Anzeigen	●	
Kraftstoffstandanzeige	●	
Anzeige für die Hydrauliköltemperatur	●	
Kraftstoffvorwärmer	●	
Warnungen	●	
Kommunikationsfehler	●	
Batterie niedrig	●	
Uhr	●	
Kabinenscheinwerfer		●
Regenschutz für Kabinenfrontfenster	●	
Kabinendachabdeckung in Stahl		●
Sitz		
Einstellbarer Fahrersitz mit Luftfederung und Heizung		●
Kabinen-FOPS/FOG (ISO/DIN 10262) Stufe 2		
FOPS (Schutzeinrichtung gegen herabfallende Gegenstände) - ISO 3449 Stufe 2		●
FOG (Schutzaufbau gegen herabfallende Gegenstände)		●
Kabinen-ROPS (ISO 12117-2)		
ROPS (Überrollschutz)	●	

SICHERHEIT	STD	OPT
Batterie Hauptschalter	●	
Heckkamera	●	
Vier Arbeitsscheinwerfer	●	
Fahralarm	●	
Arbeitsscheinwerfer hinten		●
Rundumleuchte		●
Automatische Schwenkbremse	●	
Auslegerhaltesystem	●	
Stielhaltesystem	●	
Sicherheitsventil für Auslegerzylinder mit Überlastwarneinrichtung	●	
Sicherheitsventil für Löffelstielzylinder		●
Schwenksperre		●
Zwei Außenrückspiegel	●	
SONSTIGES		
Ausleger		
5,68 m; 18' 8" Mono	●	
5,65 m; 18' 6" Zweiteiliger		●
Löffelstiel		
2,0 m; 6' 7"		●
2,4 m; 7' 10"		●
2,92 m; 9' 7"	●	
Herausnehmbares Kühlerstaubgitter	●	
Herausnehmbarer Vorratsbehälter	●	
Kraftstoffvorfilter	●	
Kraftstoffvorwärmer (einfach)	●	
Kraftstoffvorwärmer (zweifach)		●
Selbstdiagnosesystem	●	
Hi-mate (Maschinenmanagementsystem)	●	
Batterien (2 x 12 V x 100 Ah)	●	
Kraftstoffbetankungspumpe (50 l/min)		●
Einfach wirkende Verrohrung (Hydraulikhammer usw.)		●
Doppelt wirkende Verrohrung (Zweischalengreifer usw.)	●	
Verrohrung für drehende Anbaugeräte		●
Verrohrung für hydraulische Schnellwechsler		●
Einpedal-Geradeausfahrt	●	
Druckspeicher beim Senken der Arbeitseinrichtung	●	
Bedienschema-Umschaltventil (2 Muster)		●
Feinststeuerung Schwenken		●
Werkzeugsatz		●
UNTERWAGEN		
Unterbodenschutz Unterwagen (extra)		●
Unterbodenschutz Unterwagen (normal)	●	
Bodenplatten		
3-Steg-Bodenplatten (600 mm; 24")	●	
3-Steg-Bodenplatten (700 mm; 28")		●
3-Steg-Bodenplatten (800 mm; 32")		●
3-Steg-Bodenplatten (900 mm; 36")		●
Laufrollenschutz	●	

STD = Standard
OPT = Optional

- * Standard- und Wahlausstattung können je nach Modell abweichen. Weitere Informationen erhalten Sie von Ihrem Hyundai-Händler. Die Maschinenausstattung kann von internationalen Normen abhängig sein.
- * Auf den Fotos können Anbauten und optionale Geräte abgebildet sein, die in Ihrer Region nicht erhältlich sind.
- * Änderungen der Materialien und technischen Daten vorbehalten.
- * Alle Maße in angloamerikanischen Maßeinheiten sind auf das nächste volle Maß (Pound oder Zoll) gerundet.