

MOTOR		
Hersteller / Modell	Cummins QSB6.7	
Typ	Turboaufgeladener 4-Takt-Dieselmotor mit Ladeluftkühlung	
Nennleistung am Schwungrad	SAE J1995 (brutto)	142 kW (190 PS) bei 1950 U/min
	SAE J1349 (netto)	133 kW (179 PS) bei 1950 U/min
	DIN 6271/1 (brutto)	142 kW (193 PS) bei 1950 U/min
	DIN 6271/1 (netto)	133 kW (181 PS) bei 1950 U/min
Höchstdrehmoment	82,5 kgf·m (597 lbf·ft) bei 1500 U/min	
Bohrung × Hub	107 × 124 mm (4.21" × 4.88")	
Hubraum	6700 cc (409 Kubikzoll)	
Batterien	2 × 12 V × 100 Ah	
Anlasser	Denso 24 V - 4,8 kW	
Generator	Denso 24 V - 95 A	

HYDRAULIKSYSTEM	
HAUPTPUMPE	
Typ	Verstellbare Axialkolbenpumpen in Tandemausführung
Maximaler Durchfluss	2 × 228,2 l/min (60.3 U.S. gpm / 50.2 U.K. gpm)
Hilfspumpe für Vorsteuerkreis	Zahnradpumpe

Quererfassendes und kraftstoffsparendes Pumpensystem

HYDRAULIKMOTOREN	
Fahren	Axialkolbenmotor mit zwei Geschwindigkeiten mit Bremsventil und Parkbremse
Schwenken	Axialkolbenmotor mit automatischer Bremse

ÜBERDRUCKVENTILEINSTELLUNG	
Anbaugerätkreise	350 kgf/cm ² (4980 psi)
Fahren	350 kgf/cm ² (4980 psi)
Leistungsstufe (Ausleger, Löffelstiel, Löffel)	380 kgf/cm ² (5400 psi)
Schwenkkreis	300 kgf/cm ² (4270 psi)
Vorsteuerkreis	40 kgf/cm ² (569 psi)
Serviceventil	Installiert

HYDRAULIKZYLINDER	
Zylinder: Bohrung × Hub	Ausleger: Ø 135 × 1345 mm
	Löffelstiel: Ø 145 × 1620 mm
	Tiefelöffel: Ø 130 × 1185 mm

ANTRIEBE UND BREMSEN	
Antriebsart	Vollhydrostatisch
Antriebsmotor	Axialkolbenmotor, mit Bremse integriert
Untersetzung	Planetenuntersetzungsgetriebe
Max. Zugkraft	21100 kgf (46,500 lbf)
Max. Fahrgeschwindigkeit (Schnell-/Langsamgang)	5,6 km/h (3.5 mph) / 3,3 km/h (2.1 mph)
Steigfähigkeit	35° (70%)
Handbremse	Mehrscheibenausführung, nass

STEUERUNG	
Vorsteuerdruckunterstützte Joysticks und Pedale mit abnehmbarem Hebel für nahezu kraft- und ermüdungsfreie Bedienung.	
Vorsteuerung	Zwei Joysticks mit einem Sicherheitshebel (links): Schwenken und Löffelstiel (rechts): Ausleger und Tiefelöffel (ISO)
Fahren und Lenken	Zwei Hebel mit Pedalen
Motordrossel	Elektrisch, als Drehregler ausgeführt

SCHWENKWERK	
Schwenkmotor	Axialkolbenmotor mit festem Schluckvolumen
Schwenkuntersetzung	Planetenraduntersetzung
Drehkranzschmierung	Fettbad
Schwenkbremse	Mehrscheibenausführung, nass
Schwenkgeschwindigkeit	11,6 U/min

SERVICE-FÜLLMENGEN			
Nachfüllmenge	Liter	US gal	UK gal
Kraftstofftank	400	106	88
Motorkühlmittel	40	10.6	8.8
Motoröl	23	6.1	5.1
Schwenkeinrichtung	7	1.85	1.54
Endantrieb (je)	6	1.6	1.3
Hydrauliksystem (einschl. Behälter)	280	74.0	61.6
Hydraulikölbehälter	160	41.25	35.2
DEF/AdBlue®	27	7.1	5.9

UNTERWAGEN	
Der X-Mittelrahmen ist eine vollverschweißte Konstruktion mit verstärkten Kastenrahmen für das Laufwerk. Der Unterwagen ist mit geschmierten Rollen, Leiträdern, Kettenspannern mit stoßdämpfenden Federn und Antriebsrädern sowie Raupenkettenspannern mit 2- oder 3-Steg-Bodenplatten ausgerüstet.	
Mittelrahmen	X-Rahmen
Unterwagen	Fünfeckiges Kastenprofil
Kettenplatten pro Seite	51 je
Stützrollen pro Seite	2 je
Laufrollen pro Seite	9 je
Kettenführungen pro Seite	2 je

BETRIEBSGEWICHT (CIRCA)	
Betriebsgewicht, einschliesslich 5850 mm (19' 2") Ausleger; 5900 mm (19' 4") Zweiteiliger Ausleger; 3050 mm (10' 0") Löffelstiel; 1,08 m ³ (1.41 yd ³) Löffel gehäuft nach SAE, Schmiermittel, Kühlmittel, vollem Kraftstofftank, vollem Hydraulikölbehälter und aller Standardausrüstung.	

BETRIEBSGEWICHT				
Platten	Betriebsgewicht		Bodendruck	
Typ	Breite mm (in)	kg (lb)	kgf/cm ² (psi)	
Dreisteg	600 (24")	HX260 L	25600 (56,440)	0,52 (7,40)
		HX260 L Zweiteiliger Ausleger	27750 (61,178)	0,56 (7,96)
		HX260 NL	25500 (56,220)	0,52 (7,40)
		HX260 NL Zweiteiliger Ausleger	27650 (60,958)	0,56 (7,96)
		HX260 HW	27850 (61,400)	0,54 (7,68)
	700 (28")	HX260 L	25900 (57,100)	0,45 (6,40)
		HX260 L Zweiteiliger Ausleger	28050 (61,840)	0,49 (6,97)
		HX260 HW	28420 (62,650)	0,47 (6,69)
		HX260 L	26200 (57,760)	0,40 (5,69)
		HX260 L Zweiteiliger Ausleger	28350 (62,501)	0,43 (6,11)
800 (32")	HX260 HW	28800 (63,490)	0,42 (5,97)	
	HX260 L	26500 (58,420)	0,36 (5,12)	
900 (36")	HX260 L	26500 (58,420)	0,36 (5,12)	
	HX260 L Zweiteiliger Ausleger	28650 (63,162)	0,39 (5,55)	
Doppelsteg	700 (28")	HX260 HW	29330 (64,660)	0,49 (6,97)

AUSWAHLHILFE BAGGERLÖFFEL UND SCHACHTKRAFT

HX260 L

LÖFFEL

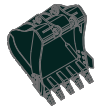

gehäuft nach SAE
m³ (yd³)

1,08 (1.41)
1,27 (1.66)
1,50 (1.96)



◆ 1,27 (1.66)

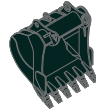

◆ 1,46 (1.91)



◆ 1,16 (1.52)

Inhalt m ³ (yd ³)		Breite mm (in)		Gewicht kg (lb)	Empfehlung mm (ft.in)						
gehäuft nach SAE	gehäuft nach CECE	Ohne Seiten- schneidkanten	Mit Seiten- schneidkanten		5850 (19' 2") Ausleger				5900 (19' 4") Zweiteiliger Ausleger		
					2100 (6' 11") Löffelstiel	2500 (8' 2") Löffelstiel	3050 (10' 0") Löffelstiel	3600 (11' 10") Löffelstiel	2100 (6' 11") Löffelstiel	2500 (8' 2") Löffelstiel	3050 (10' 0") Löffelstiel
1,08 (1.41)	0,95 (1.24)	1170 (46.1)	1250 (49.2)	1020 (2,250)	●	●	●	⊙	●	●	●
1,27 (1.66)	1,11 (1.45)	1325 (52.2)	1410 (55.5)	1100 (2,430)	●	⊙	⊙	○	●	●	⊙
1,50 (1.96)	1,30 (1.70)	1515 (59.6)	1600 (63.0)	1180 (2,600)	●	⊙	●	-	⊙	⊙	○
◆ 1,27 (1.66)	1,11 (1.45)	1380 (54.3)	-	1290 (2,840)	●	⊙	○	-	●	●	⊙
◆ 1,46 (1.91)	1,28 (1.67)	1535 (60.4)	-	1380 (3,040)	⊙	○	○	-	⊙	⊙	○
◆ 1,16 (1.52)	1,00 (1.31)	1285 (50.6)	-	1380 (3,040)	●	⊙	○	-	●	●	⊙

- ◆ Tieflöffel für hohe Beanspruchung
- ◆ Felslöffel für hohe Beanspruchung

- : Für Material mit einer Dichte von maximal 2000 kg / m³ (3370 lb/ yd³)
- ⊙ : Für Material mit einer Dichte von maximal 1600 kg / m³ (2700 lb/ yd³)
- : Für Material mit einer Dichte von maximal 1100 kg / m³ (1850 lb/ yd³)

ANBAUGERÄT

Ausleger und Löffelstiel sind als verschweißtes, spannungsarmes Kastenprofil ausgeführt.

Erhältlich: Ausleger in 5,85 m (19' 2") und Zweiteiliger Ausleger in 5,9 m (19' 4") und Löffelstiel in 2,1 m (6' 11"); 2,5 m (8' 2"); 3,05 m (10' 0") und 3,6 m (11' 10").

SCHACHTKRAFT

Ausleger	Länge	mm (ft.in)	5850 (19' 2")				Anmer- kungen:
	Gewicht	kg (lb)	2460 (5,420)				
Löffelstiel	Länge	mm (ft.in)	2100 (6' 11")	2500 (8' 2")	3050 (10' 0")	3600 (11' 10")	[]: Leistungs- stufe
	Gewicht	kg (lb)	1420 (3,130)	1450 (3,200)	1540 (3,400)	1600 (3,530)	
Tieflöffel Losbrech- kraft	SAE	kN	156,9 [170,4]	156,9 [170,4]	156,9 [170,4]	156,9 [170,4]	
		kgf	16000 [17370]	16000 [17370]	16000 [17370]	16000 [17370]	
		lbf	35270 [38290]	35270 [38290]	35270 [38290]	35270 [38290]	
	ISO	kN	178,5 [193,8]	178,5 [193,8]	178,5 [193,8]	178,5 [193,8]	
		kgf	18200 [19760]	18200 [19760]	18200 [19760]	18200 [19760]	
		lbf	40120 [43560]	40120 [43560]	40120 [43560]	40120 [43560]	
Tieflöffelstiel Reißkraft	SAE	kN	134,4 [145,9]	130,4 [141,6]	114,7 [124,6]	104,0 [112,9]	
		kgf	13700 [14870]	13300 [14440]	11700 [12700]	10600 [11510]	
		lbf	30200 [32790]	29320 [31830]	25790 [28000]	23370 [25370]	
	ISO	kN	139,3 [151,2]	134,4 [145,9]	118,7 [128,8]	107,9 [117,1]	
		kgf	14200 [15420]	13700 [14870]	12100 [13140]	11000 [11940]	
		lbf	31310 [33990]	30200 [32790]	26680 [28970]	24250 [26330]	

Hinweis : Auslegergewicht inklusive Stielzylinder, Verrohrung und Bolzen.
Stielgewicht inklusive Löffelzylinder, Verbindungsstangen und Bolzen.

MASSE UND ARBEITSBEREICH

HX260 L

ABMESSUNGEN HX260 L / HX260 NL

Ausleger in 5,85 m (20' 6") und Löffelstiel in 2,1 m (6' 11"); 2,5 m (8' 2"); 3,05 m (10' 0") und 3,6 m (11' 10")

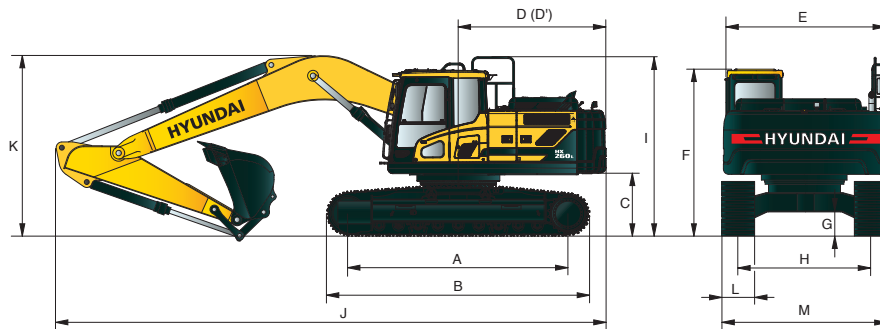

Einheit : mm (ft-in)

A	Aufstandslänge	3830 (12' 7")
B	Gesamtlänge der Raupe	4680 (15' 4")
C	Bodenfreiheit des Heckgegengewichts	1115 (3' 8")
D	Heckschwenkradius	2975 (9' 9")
D'	Hecklänge	2870 (9' 5")
E	Gesamtbreite des Oberwagens	2840 (9' 4")
F	Gesamthöhe der Kabine	3050 (10' 0")
G	Mindest-Bodenfreiheit	480 (1' 7")
H	Spurweite	HX260 L 2580 (8' 6") HX260 NL 2380 (7' 10")
I	Gesamthöhe des Schutzgeländers	3260 (10' 7")

Auslegerlänge	5850 (19' 2")			
Löffelstiellänge	2100 (6' 11")	2500 (8' 2")	3050 (10' 0")	3600 (11' 10")
J Gesamtlänge	10050 (32' 12")	10000 (32' 10")	9920 (32' 7")	9910 (32' 6")
K Gesamthöhe des Auslegers	3530 (11' 7")	3590 (11' 9")	3220 (10' 7")	3590 (11' 9")
L Breite der Bodenplatten	600 (24")	700 (28")	800 (32")	900 (36")
M Gesamtbreite	HX260 L 3180 (10' 5") HX260 NL 2980 (9' 9")	3280 (10' 9")	3380 (11' 1")	3480 (11' 5") 3280 (10' 9")

ARBEITSBEREICH HX260 L / HX260 NL

Einheit : mm (ft-in)

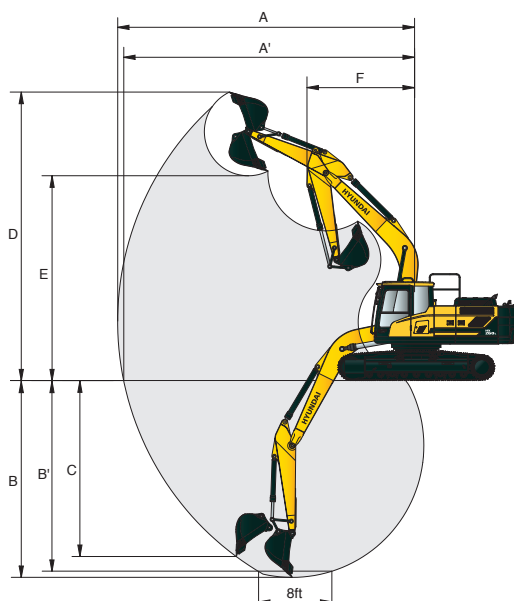

Auslegerlänge	5850 (19' 2")			
Löffelstiellänge	2100 (6' 11")	2500 (8' 2")	3050 (10' 0")	3600 (11' 10")
A Max. Schachtweite	9550 (31' 4")	9870 (32' 5")	10360 (34' 0")	10870 (35' 8")
A' Max. Schachtweite am Boden	9360 (30' 9")	9680 (31' 9")	10190 (33' 5")	10700 (35' 1")
B Max. Schachttiefe	6050 (19' 10")	6450 (21' 2")	7000 (23' 0")	7550 (24' 9")
B' Max. Schachttiefe (auf ca. 2,40 m)	5840 (19' 2")	6260 (20' 6")	6830 (22' 5")	7400 (24' 3")
C Max. vertikale Abstechtiefe	5480 (18' 0")	5640 (18' 6")	6150 (20' 2")	6830 (22' 5")
D Max. Einstechhöhe	9450 (31' 0")	9460 (31' 0")	9670 (31' 9")	9920 (32' 7")
E Max. Ladehöhe	6360 (20' 10")	6420 (21' 1")	6630 (21' 9")	6860 (22' 6")
F Min. Frontschwenkradius	4420 (14' 6")	4200 (13' 9")	3980 (13' 1")	3900 (12' 10")

MASSE UND ARBEITSBEREICH

HX260 L

ABMESSUNGEN HX260 L HIGH WALKER

Ausleger in 5,85 m (19' 2") und Löffelstiel in 2,1 m (6' 11"); 2,5 m (8' 2"); 3,05 m (10' 0") und 3,6 m (11' 0")

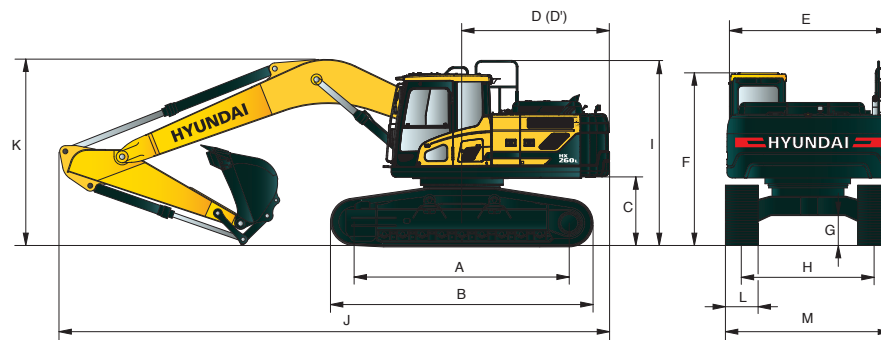

Einheit : mm (ft-in)

A	Aufstandslänge	4030 (13' 3")
B	Gesamtlänge der Raupe	4880 (16' 0")
C	Bodenfreiheit des Heckgegengewichts	1470 (4' 10")
D	Heckschwenkradius	2975 (9' 9")
D'	Hecklänge	2870 (9' 5")
E	Gesamtbreite des Oberwagens	2840 (9' 4")
F	Gesamthöhe der Kabine	3420 (11' 2")
G	Mindest-Bodenfreiheit	765 (2' 6")
H	Spurweite	2790 (9' 2")
I	Gesamthöhe des Schutzgelanders	3625 (11' 9")

Auslegerlänge	5850 (19' 2")			
Löffelstiellänge	2100 (6' 11")	2500 (8' 2")	3050 (10' 0")	3600 (11' 10")
J Gesamtlänge	10060 (33' 0")	9970 (32' 9")	9760 (32' 0")	9930 (32' 7")
K Gesamthöhe des Auslegers	3610 (11' 10")	3750 (12' 4")	3240 (10' 8")	3620 (11' 11")
L Bodenplatten	Typ	Dreisteg		Doppelsteg
	Breite	600 (24")	700 (28")	800 (32")
M Gesamtbreite	3390 (11' 1")	3490 (11' 5")	3590 (11' 9")	3490 (11' 5")

ARBEITSBEREICH HX260 L HIGH WALKER

Einheit : mm (ft-in)

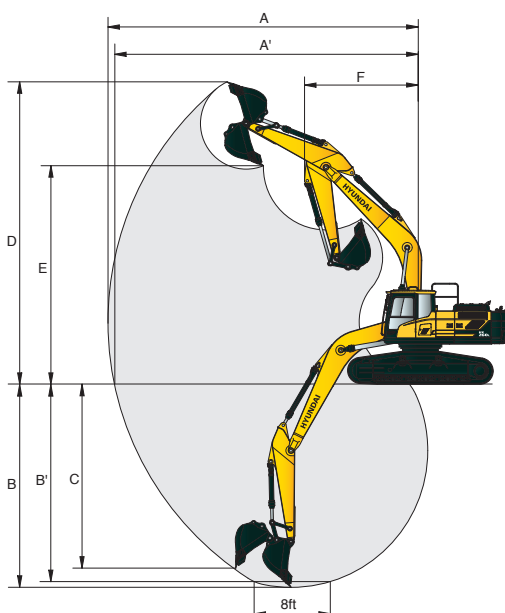

Auslegerlänge	5850 (19' 2")			
Löffelstiellänge	2100 (6' 11")	2500 (8' 2")	3050 (10' 0")	3600 (11' 10")
A Max. Schachtweite	9550 (31' 4")	9870 (32' 5")	10360 (34' 0")	10870 (35' 8")
A' Max. Schachtweite am Boden	9280 (30' 5")	9160 (30' 1")	10110 (33' 2")	10360 (34' 0")
B Max. Schachttiefe	5680 (18' 8")	6080 (19' 11")	6630 (21' 9")	7180 (23' 7")
B' Max. Schachttiefe (auf ca. 2,40 m)	5470 (17' 11")	5890 (19' 4")	6460 (21' 2")	7030 (23' 1")
C Max. vertikale Abstechtiefe	5120 (16' 10")	5300 (17' 5")	5790 (19' 0")	6470 (21' 3")
D Max. Einstechhöhe	9820 (32' 3")	9840 (32' 3")	10040 (32' 11")	10280 (33' 9")
E Max. Ladehöhe	6730 (22' 1")	6790 (22' 3")	7000 (23' 0")	7220 (23' 8")
F Min. Frontschwenkradius	4140 (13' 7")	4030 (13' 3")	3940 (12' 11")	3900 (12' 10")

MASSE UND ARBEITSBEREICH

HX260 L

ABMESSUNGEN HX260 L ZWEITEILIGER AUSLEGER

Zweiteiliger Ausleger in 5,85 m (20' 6") und Löffelstiel in 2,1 m (6' 11"); 2,5 m (8' 2"); 3,05 m (10' 0") und 3,6 m (11' 10") Löffelstiel

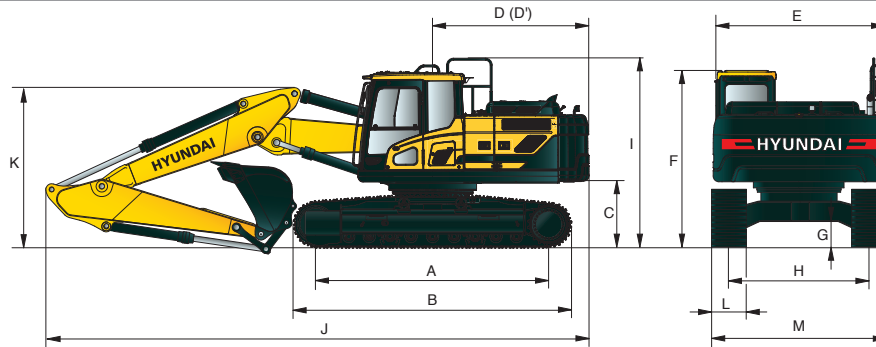

Einheit: mm (ft-in)

A	Aufstandslänge	3830 (12' 7")
B	Gesamtlänge der Raupe	4680 (15' 4")
C	Bodenfreiheit des Heckgegengewichts	1115 (3' 8")
D	Heckschwenkradius	2975 (9' 9")
D'	Hecklänge	2870 (9' 5")
E	Gesamtbreite des Oberwagens	2840 (9' 4")
F	Gesamthöhe der Kabine	3050 (10' 0")
G	Mindest-Bodenfreiheit	480 (1' 7")
H	Spurweite	HX260 L 2580 (8' 6")
		HX260 NL 2380 (7' 10")
I	Gesamthöhe des Schutzgeländers	3260 (10' 7")

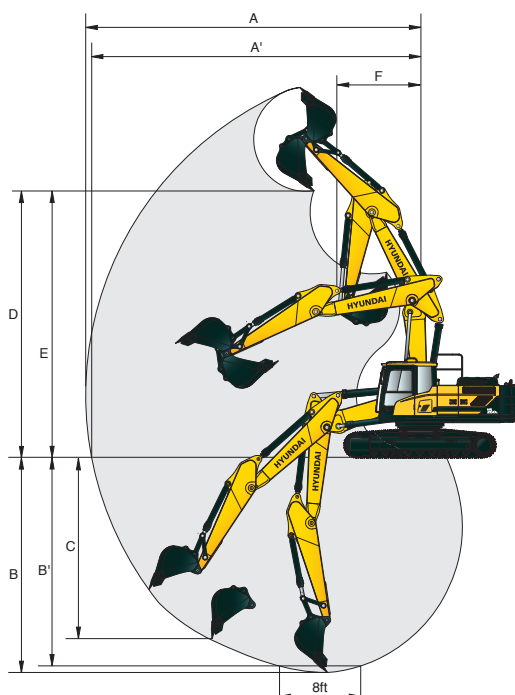

Auslegerlänge	5850 (19' 2")			
Löffelstiellänge	2100 (6' 11")	2500 (8' 2")	3050 (10' 0")	3600 (11' 10")
J Gesamtlänge	10110 (33' 2")	10010 (32' 10")	9990 (32' 9")	9930 (32' 7")
K Gesamthöhe des Auslegers	3320 (10' 11")	3260 (10' 8")	3210 (10' 6")	3590 (11' 9")
L Breite der Bodenplatten	600 (24")	700 (28")	800 (32")	900 (36")
M Gesamtbreite	HX260 L 3180 (10' 5")	HX260 L 3280 (10' 9")	HX260 L 3380 (11' 1")	HX260 L 3480 (11' 5")
	HX260 NL 2980 (9' 9")	HX260 NL 3080 (10' 2")	HX260 NL 3180 (10' 5")	HX260 NL 3280 (10' 9")

ARBEITSBEREICH HX260 L / HX260 NL













Einheit: mm (ft-in)

Auslegerlänge	5850 (19' 2")			
Löffelstiellänge	2100 (6' 11")	2500 (8' 2")	3050 (10' 0")	3600 (11' 10")
A Max. Schachtweite	9660 (31' 8")	9900 (32' 9")	10500 (34' 5")	11020 (36' 2")
A' Max. Schachtweite am Boden	9470 (31' 1")	9810 (32' 2")	10320 (33' 10")	10850 (35' 7")
B Max. Schachttiefe	5750 (18' 10")	6120 (20' 1")	6660 (21' 10")	7200 (23' 8")
B' Max. Schachttiefe (auf ca. 2,40 m)	5840 (19' 2")	6260 (20' 6")	6830 (22' 5")	7400 (24' 3")
C Max. vertikale Abstechtiefe	4780 (15' 8")	5100 (16' 9")	5620 (18' 5")	6230 (20' 5")
D Max. Einstechhöhe	10880 (35' 8")	11090 (36' 5")	11470 (37' 8")	11870 (38' 11")
E Max. Ladehöhe	7660 (25' 2")	7870 (25' 10")	8250 (27' 1")	6640 (21' 10")
F Min. Frontschwenkradius	3280 (10' 9")	2990 (9' 10")	2730 (8' 11")	3100 (10' 2")











 Lastradius Frontauslage  Lastradius Seitenauslage bzw. 360 Grad

HX260 L

5,85 m (19' 2") Ausleger; 2,10 m (6' 11") Löffelstiel; 1,08 m³ Löffel (nach SAE gehäuft); 600 mm (24") 3-Steg-Bodenplatten.

Lasthöhe m (ft)	Lastradius								Max. Reichweite		
	3.0 m (10 ft)		4.5 m (15 ft)		6.0 m (20 ft)		7.5 m (25 ft)		Volumen		Reichweite m (ft)
											
7.5 m (25 ft)	kg								*7270	7230	5.55
	lb								*16030	15940	(18.2)
6.0 m (20 ft)	kg			*7010	6340				*7110	5140	6.77
	lb			*15450	13980				*15670	11330	(22.2)
4.5 m (15 ft)	kg		*9290	*9290	*7660	6110			6630	4260	7.49
	lb		*20480	*20480	*16890	13470			14620	9390	(24.6)
3.0 m (10 ft)	kg				*8720	5790	6490	4140	6020	3840	7.86
	lb				*19220	12760	14310	9130	13270	8470	(25.8)
1.5 m (5 ft)	kg				8900	5500	6350	4010	5850	3700	7.93
	lb				19620	12130	14000	8840	12900	8160	(26.0)
Boden-niveau	kg		13980	8070	8720	5340	6270	3940	6040	3800	7.70
	lb		30820	17790	19220	11770	13820	8690	13320	8380	(25.3)
-1.5 m (-5 ft)	kg		*13690	8100	8690	5320			6730	4210	7.16
	lb		*30180	17860	19160	11730			14840	9280	(23.5)
-3.0 m (-10 ft)	kg	*16700	*16700	*12340	8270	8870	5470		8460	5250	6.20
	lb	*36820	*36820	*27210	18230	19550	12060		18650	11570	(20.4)
-4.5 m (-15 ft)	kg										
	lb										

5,85 m (19' 2") Ausleger; 2,50 m (8' 2") Löffelstiel; 1,08 m³ Löffel (nach SAE gehäuft); 600 mm (24") 3-Steg-Bodenplatten.

Lasthöhe m (ft)	Lastradius								Max. Reichweite			
	3.0 m (10 ft)		4.5 m (15 ft)		6.0 m (20 ft)		7.5 m (25 ft)		Volumen		Reichweite m (ft)	
												
7.5 m (25 ft)	kg								*6080	*6080	6.00	
	lb								*13400	*13400	(19.7)	
6.0 m (20 ft)	kg				*6490	6430			*5650	4750	7.14	
	lb				14310	14180			*12460	10470	(23.4)	
4.5 m (15 ft)	kg		*8580	*8580	*7230	6180	6670	4300	*5580	3990	7.82	
	lb		*18920	*18920	15940	13620	14700	9480	*12300	8800	(25.7)	
3.0 m (10 ft)	kg		*11080	8940	*8340	5840	6520	4160	5670	3610	8.18	
	lb		*24430	19710	18390	12870	14370	9170	12500	7960	(26.8)	
1.5 m (5 ft)	kg		*13130	8330	8940	5530	6360	4010	5500	3480	8.25	
	lb		*28950	18360	19710	12190	14020	8840	12130	7670	(27.1)	
Boden-niveau	kg		13980	8060	8720	5340	6240	3910	5660	3550	8.03	
	lb		30820	17770	19220	11770	13760	8620	12480	7830	(26.3)	
-1.5 m (-5 ft)	kg	*11520	*11520	*13870	8040	8650	5270	6240	3900	6230	3900	7.51
	lb	*25400	*25400	*30580	17730	19070	11620	13760	8600	13730	8600	(24.6)
-3.0 m (-10 ft)	kg	*17880	16500	*12820	8170	8750	5360		7610	4730	6.61	
	lb	*39420	36380	*28260	18010	19290	11820		16780	10430	(21.7)	
-4.5 m (-15 ft)	kg			*10090	8530				*8520	7080	5.12	
	lb			*22240	18810				*18780	15610	(16.8)	













1. Die Hublast richtet sich nach der Definition in SAE J1097 und ISO 10567.
2. Die Hublast der Serie ROBEX darf auf festem, ebenem Untergrund maximal 75 % der Kipplast der Maschine bzw. 87 % der gesamten hydraulischen Hubkraft betragen.

3. Der Lasthaken befindet sich an der Rückseite des Tieflöffels.
4. (*) gibt die Lastbegrenzung durch die hydraulische Hubkraft an.















 Lastradius Frontauslage  Lastradius Seitenauslage bzw. 360 Grad

HX260 L

5,85 m (19' 2") Ausleger; 3,05 m (10' 0") Löffelstiel; 1,08 m³ Löffel (nach SAE gehäuft); 600 mm (24") 3-Steg-Bodenplatten.



Lasthöhe m (ft)	Lastradius										Max. Reichweite			
	1.5 m (5 ft)		3.0 m (10 ft)		4.5 m (15 ft)		6.0 m (20 ft)		7.5 m (25 ft)		Volumen		Reichweite m (ft)	
														
7.5 m (25 ft)	kg											*4010	*4010	6.66
	lb											*8840	*8840	(21.8)
6.0 m (20 ft)	kg							*4710	4420			*3760	*3760	7.70
	lb							*10380	9740			*8290	*8290	(25.3)
4.5 m (15 ft)	kg						*6560	6270		*6140	4340	*3720	3590	8.34
	lb						*14460	13820		*13540	9570	*8200	7910	(27.4)
3.0 m (10 ft)	kg			*10040	9160		*7740	5910		6540	4170	*3830	3270	8.67
	lb			*22130	20190		*17060	13030		14420	9190	*8440	7210	(28.5)
1.5 m (5 ft)	kg			*12360	8430		*8950	5550		6350	3990	*4090	3150	8.74
	lb			*27250	18580		*19730	12240		14000	8800	*9020	6940	(28.7)
Boden-niveau	kg		*6350	*6350	*13650	8040	8700	5310		6200	3860	*4570	3200	8.53
	lb		*14000	*14000	*30090	17730	19180	11710		13670	8510	*10080	7050	(28.0)
-1.5 m (-5 ft)	kg	*7170	*7170	*11190	*11190	13840	7930	8570	5190	6130	3800	*5400	3460	8.04
	lb	*15810	*15810	*24670	*24670	30510	17480	18890	11440	13510	8380	*11900	7630	(26.4)
-3.0 m (-10 ft)	kg	*12120	*12120	*17600	16150	*13270	8000	8600	5220			6570	4080	7.21
	lb	*26720	*26720	*38800	35600	*29260	17640	18960	11510			14480	8990	(23.7)
-4.5 m (-15 ft)	kg			*16000	*16000	*11330	8260					*8180	5610	5.88
	lb			*35270	*35270	*24980	18210					*18030	12370	(19.3)

5,85 m (19' 2") Ausleger; 3,60 m (11' 10") Löffelstiel; 1,08 m³ Löffel (nach SAE gehäuft); 600 mm (24") 3-Steg-Bodenplatten.

Lasthöhe m (ft)	Lastradius										Max. Reichweite					
	1.5 m (5 ft)		3.0 m (10 ft)		4.5 m (15 ft)		6.0 m (20 ft)		7.5 m (25 ft)		9.0 m (30 ft)		Volumen		Reichweite m (ft)	
																
7.5 m (25 ft)	kg													*3470	*3470	7.32
	lb													*7650	*7650	(24.0)
6.0 m (20 ft)	kg							*5150	4500					*3280	*3280	8.27
	lb							*11350	9920					*7230	*7230	(27.1)
4.5 m (15 ft)	kg							*5870	*5870	*5590	4380			*3250	3220	8.87
	lb							*12940	*12940	*12320	9660			*7170	7100	(29.1)
3.0 m (10 ft)	kg			*8940	*8940	*7100	5980	*6220	4190	*4240	3070	*3340	2950	9.19		
	lb			*19710	*19710	*15650	13180	*13710	9240	*9350	6770	*7360	6500	(30.1)		
1.5 m (5 ft)	kg			*11460	8550	*8400	5580	6340	3980	4760	2970	*3540	2840	9.25		
	lb			*25260	18850	*18520	12300	13980	8770	10490	6550	*7800	6260	(30.3)		
Boden-niveau	kg			*7080	*7080	*13130	8030	8680	5280	6160	3810	*4310	2900	*3910	2870	9.05
	lb			*15610	*15610	*28950	17700	19140	11640	13580	8400	*9500	6390	*8620	6330	(29.7)
-1.5 m (-5 ft)	kg	*6430	*6430	*10500	*10500	13720	7820	8490	5110	6050	3720	*4550	3070	8.60		
	lb	*14180	*14180	*23150	*23150	30250	17240	18720	11270	13340	8200	*10030	6770	(28.2)		
-3.0 m (-10 ft)	kg	*10430	*10430	*15460	*15460	*13510	7820	8470	5090	6070	3730	*5720	3530	7.82		
	lb	*22990	*22990	*34080	*34080	*29780	17240	18670	11220	13380	8220	*12610	7780	(25.7)		
-4.5 m (-15 ft)	kg	*15500	*15500	*17530	16210	*12140	8020	8630	5230			7460	4590	6.62		
	lb	*34170	*34170	*38650	35740	*26760	17680	19030	11530			16450	10120	(21.7)		
-6.0 m (-20 ft)	kg															
	lb															











- Die Hublast richtet sich nach der Definition in SAE J1097 und ISO 10567.
- Die Hublast der Serie ROBEX darf auf festem, ebenem Untergrund maximal 75 % der Kipplast der Maschine bzw. 87 % der gesamten hydraulischen Hubkraft betragen.

- Der Lasthaken befindet sich an der Rückseite des Tieflöffels.
- (*) gibt die Lastbegrenzung durch die hydraulische Hubkraft an.











 Lastradius Frontauslage  Lastradius Seitenauslage bzw. 360 Grad

HX260 NL

5,85 m (19' 2") Ausleger; 2,10 m (6' 11") Löffelstiel; 1,08 m³ Löffel (nach SAE gehäuft); 600 mm (24") 3-Steg-Bodenplatten.

Lasthöhe m (ft)	Lastradius								Max. Reichweite		
	3.0 m (10 ft)		4.5 m (15 ft)		6.0 m (20 ft)		7.5 m (25 ft)		Volumen		Reichweite m (ft)
											
7.5 m (25 ft)	kg								*7280	6700	5.50
	lb								*16050	14770	(18.1)
6.0 m (20 ft)	kg			*7000	5800				*7110	4730	6.74
	lb			*15430	12790				*15670	10430	(22.1)
4.5 m (15 ft)	kg		*9230	8700	*7640	5580			6620	3890	7.47
	lb		*20350	19180	*16840	12300			14590	8580	(24.5)
3.0 m (10 ft)	kg				*8690	5260	6470	3760	6010	3490	7.85
	lb				*19160	11600	14260	8290	13250	7690	(25.8)
1.5 m (5 ft)	kg				8870	4980	6330	3640	5820	3350	7.93
	lb				19550	10980	13960	8020	12830	7390	(26.0)
Boden- niveau	kg		13920	7220	8690	4820	6240	3560	6000	3430	7.72
	lb		30690	15920	19160	10630	13760	7850	13230	7560	(25.3)
-1.5 m (-5 ft)	kg		*13710	7240	8650	4790			6670	3800	7.18
	lb		*30230	15960	19070	10560			14700	8380	(23.6)
-3.0 m (-10 ft)	kg	*16780	14630	*12390	7410	8820	4940		8350	4710	6.24
	lb	*36990	32250	*27320	16340	19440	10890		18410	10380	(20.5)
-4.5 m (-15 ft)	kg										
	lb										

5,85 m (19' 2") Ausleger; 2,50 m (8' 2") Löffelstiel; 1,08 m³ Löffel (nach SAE gehäuft); 600 mm (24") 3-Steg-Bodenplatten.

Lasthöhe m (ft)	Lastradius								Max. Reichweite			
	3.0 m (10 ft)		4.5 m (15 ft)		6.0 m (20 ft)		7.5 m (25 ft)		Volumen		Reichweite m (ft)	
												
7.5 m (25 ft)	kg								*6100	5960	5.96	
	lb								*13450	13140	(19.5)	
6.0 m (20 ft)	kg				*6480	5890			*5660	4370	7.11	
	lb				*14290	12990			*12480	9630	(23.3)	
4.5 m (15 ft)	kg		*8510	*8510	*7200	5650	6650	3920	*5580	3640	7.81	
	lb		*18760	*18760	*15870	12460	14660	8640	*12300	8020	(25.6)	
3.0 m (10 ft)	kg		*11010	8090	*8310	5320	6500	3790	5650	3290	8.17	
	lb		*24270	17840	*18320	11730	14330	8360	12460	7250	(26.8)	
1.5 m (5 ft)	kg		*13090	7480	8910	5010	6330	3640	5480	3150	8.25	
	lb		*28860	16490	19640	11050	13960	8020	12080	6940	(27.1)	
Boden- niveau	kg		13930	7220	8690	4820	6220	3530	5620	3210	8.04	
	lb		30710	15920	19160	10630	13710	7780	12390	7080	(26.4)	
-1.5 m (-5 ft)	kg	*11300	*11300	13890	7180	8610	4750	6210	3530	6180	3510	7.53
	lb	*24910	*24910	30620	15830	18980	10470	13690	7780	13620	7740	(24.7)
-3.0 m (-10 ft)	kg	*17960	14410	*12870	7310	8710	4830		7520	4250	6.64	
	lb	*39590	31770	*28370	16120	19200	10650		16580	9370	(21.8)	
-4.5 m (-15 ft)	kg	*14200	*14200	*10210	7650				*8520	6280	5.17	
	lb	*31310	*31310	*22510	16870				*18780	13850	(17.0)	













1. Die Hublast richtet sich nach der Definition in SAE J1097 und ISO 10567.
2. Die Hublast der Serie ROBEX darf auf festem, ebenem Untergrund maximal 75 % der Kipplast der Maschine bzw. 87 % der gesamten hydraulischen Hubkraft betragen.

3. Der Lasthaken befindet sich an der Rückseite des Tieflöffels.
4. (*) gibt die Lastbegrenzung durch die hydraulische Hubkraft an.













 Lastradius Frontauslage  Lastradius Seitenauslage bzw. 360 Grad

HX260 NL

5,85 m (19' 2") Ausleger; 3,05 m (10' 0") Löffelstiel; 1,08 m³ Löffel (nach SAE gehäuft); 600 mm (24") 3-Steg-Bodenplatten.

Lasthöhe m (ft)	Lastradius										Max. Reichweite			
	1.5 m (5 ft)		3.0 m (10 ft)		4.5 m (15 ft)		6.0 m (20 ft)		7.5 m (25 ft)		Volumen		Reichweite m (ft)	
														
7.5 m (25 ft)	kg										*4020	*4020	6.62	
	lb										*8860	*8860	(21.7)	
6.0 m (20 ft)	kg							*4610	4040		*3770	*3770	7.68	
	lb							*10160	8910		*8310	*8310	(25.2)	
4.5 m (15 ft)	kg						*6540	5730			*3720	3270	8.33	
	lb						*14420	12630			*8200	7210	(27.3)	
3.0 m (10 ft)	kg				*9970	8290	*7710	5380	6520	3790	*3830	2970	8.67	
	lb				*21980	18280	*17000	11860	14370	8360	*8440	6550	(28.4)	
1.5 m (5 ft)	kg				*12300	7580	*8920	5030	6320	3620	*4080	2840	8.74	
	lb				*27120	16710	*19670	11090	13930	7980	*8990	6260	(28.7)	
Boden-niveau	kg		*6220	*6220	*13630	7200	8670	4790	6170	3480	*4550	2880	8.54	
	lb		*13710	*13710	*30050	15870	19110	10560	13600	7670	*10030	6350	(28.0)	
-1.5 m (-5 ft)	kg	*7030	*7030	*11040	*11040	13780	7080	8530	4670	6110	3430	*5370	3110	8.06
	lb	*15500	*15500	*24340	*24340	30380	15610	18810	10300	13470	7560	*11840	6860	(26.5)
-3.0 m (-10 ft)	kg	*11970	*11970	*17390	14080	*13300	7140	8560	4700			6500	3660	7.24
	lb	*26390	*26390	*38340	31040	*29320	15740	18870	10360			14330	8070	(23.8)
-4.5 m (-15 ft)	kg			*16120	14540	*11410	7390					*8170	5000	5.93
	lb			*35540	32060	*25150	16290					*18010	11020	(19.5)

5,85 m (19' 2") Ausleger; 3,60 m (11' 10") Löffelstiel; 1,08 m³ Löffel (nach SAE gehäuft); 600 mm (24") 3-Steg-Bodenplatten.

Lasthöhe m (ft)	Lastradius										Max. Reichweite				
	1.5 m (5 ft)		3.0 m (10 ft)		4.5 m (15 ft)		6.0 m (20 ft)		7.5 m (25 ft)		9.0 m (30 ft)		Volumen		Reichweite m (ft)
															
7.5 m (25 ft)	kg												*3480	*3480	7.28
	lb												*7670	*7670	(23.9)
6.0 m (20 ft)	kg							*5120	4120				*3280	*3280	8.25
	lb							*11290	9080				*7230	*7230	(27.1)
4.5 m (15 ft)	kg						*5840	5830	*5570	4000			*3250	2930	8.86
	lb						*12870	12850	*12280	8820			*7170	6460	(29.1)
3.0 m (10 ft)	kg				*8870	8510	*7060	5450	*6200	3810	*4210	2770	*3330	2670	9.18
	lb				*19550	18760	*15560	12020	*13670	8400	*9280	6110	*7340	5890	(30.1)
1.5 m (5 ft)	kg				*11400	7700	*8370	5060	6320	3610	4740	2680	*3540	2560	9.25
	lb				*25130	16980	*18450	11160	13930	7960	10450	5910	*7800	5640	(30.3)
Boden-niveau	kg		*7000	*7000	*13090	7180	8650	4760	6130	3440	*4350	2610	*3900	2580	9.06
	lb		*15430	*15430	*28860	15830	19070	10490	13510	7580	*9590	5750	*8600	5690	(29.7)
-1.5 m (-5 ft)	kg	*6330	*6330	*10380	*10380	13670	6970	8460	4590	6030	3340		*4520	2750	8.61
	lb	*13960	*13960	*22880	*22880	30140	15370	18650	10120	13290	7360		*9960	6060	(28.3)
-3.0 m (-10 ft)	kg	*10310	*10310	*15300	13720	*13530	6970	8430	4570	6040	3350		5670	3160	7.85
	lb	*22730	*22730	*33730	30250	*29830	15370	18580	10080	13320	7390		12500	6970	(25.8)
-4.5 m (-15 ft)	kg	*15330	*15330	*17620	14120	*12200	7150	8580	4700				7350	4100	6.66
	lb	*33800	*33800	*38850	31130	*26900	15760	18920	10360				16200	9040	(21.9)
-6.0 m (-20 ft)	kg														
	lb														











- Die Hublast richtet sich nach der Definition in SAE J1097 und ISO 10567.
- Die Hublast der Serie ROBEX darf auf festem, ebenem Untergrund maximal 75 % der Kipplast der Maschine bzw. 87 % der gesamten hydraulischen Hubkraft betragen.

- Der Lasthaken befindet sich an der Rückseite des Tieflöffels.
- (*) gibt die Lastbegrenzung durch die hydraulische Hubkraft an.











 Lastradius Frontauslage  Lastradius Seitenauslage bzw. 360 Grad

HX260 L HIGH WALKER

5,85 m (19' 2") Ausleger; 2,10 m (6' 11") Löffelstiel; 1,08 m³ Löffel (nach SAE gehäuft); 600 mm (24") 3-Steg-Bodenplatten.

Lasthöhe m (ft)	Lastradius								Max. Reichweite			
	3.0 m (10 ft)		4.5 m (15 ft)		6.0 m (20 ft)		7.5 m (25 ft)		Volumen		Reichweite m (ft)	
												
7.5 m (25 ft)	kg									*7200	*7200	5.87
	lb									*15870	*15870	(19.2)
6.0 m (20 ft)	kg				*7090	*7090				*7110	5850	6.96
	lb				*15630	*15630				*15670	12900	(22.8)
4.5 m (15 ft)	kg		*9810	*9810	*7870	7240	*7200	5100		*7200	4990	7.60
	lb		*21630	*21630	*17350	15960	*15870	11240		*15870	11000	(24.9)
3.0 m (10 ft)	kg				*8950	6910	*7570	4970		7020	4590	7.90
	lb				*19730	15230	*16690	10960		15480	10120	(25.9)
1.5 m (5 ft)	kg				*9880	6640	7480	4850		6920	4500	7.91
	lb				*21780	14640	16490	10690		15260	9920	(25.9)
Boden- niveau	kg		*14070	9920	*10320	6500	7420	4790		7270	4700	7.62
	lb		*31020	21870	*22750	14330	16360	10560		16030	10360	(25.0)
-1.5 m (-5 ft)	kg		*13500	9980	*10090	6510				8270	5310	6.99
	lb		*29760	22000	*22240	14350				18230	11710	(22.9)
-3.0 m (-10 ft)	kg	*16020	*16020	*11850	10200					*8570	6840	5.93
	lb	*35320	*35320	*26120	22490					*18890	15080	(19.4)

5,85 m (19' 2") Ausleger; 2,50 m (8' 2") Löffelstiel; 1,08 m³ Löffel (nach SAE gehäuft); 600 mm (24") 3-Steg-Bodenplatten.

Lasthöhe m (ft)	Lastradius								Max. Reichweite			
	3.0 m (10 ft)		4.5 m (15 ft)		6.0 m (20 ft)		7.5 m (25 ft)		Volumen		Reichweite m (ft)	
												
7.5 m (25 ft)	kg				*6470	*6470				*5950	*5950	6.29
	lb				*14260	*14260				*13120	*13120	(20.6)
6.0 m (20 ft)	kg				*6600	*6600				*5610	5440	7.32
	lb				*14550	*14550				*12370	11990	(24.0)
4.5 m (15 ft)	kg		*9090	*9090	*7450	7310	*6780	5140		*5590	4680	7.93
	lb		*20040	*20040	*16420	16120	*14950	11330		*12320	10320	(26.0)
3.0 m (10 ft)	kg		*11610	10670	*8590	6960	*7280	4990		*5810	4330	8.22
	lb		*25600	23520	*18940	15340	*16050	11000		*12810	9550	(27.0)
1.5 m (5 ft)	kg		*13420	10110	*9620	6660	7480	4840		*6280	4240	8.22
	lb		*29590	22290	*21210	14680	16490	10670		*13850	9350	(27.0)
Boden- niveau	kg		*14040	9900	*10220	6490	7390	4760		6800	4400	7.95
	lb		*30950	21830	*22530	14310	16290	10490		14990	9700	(26.1)
-1.5 m (-5 ft)	kg	*13280	*13280	*13730	9910	*10190	6460			7630	4910	7.35
	lb	*29280	*29280	*30270	21850	*22470	14240			16820	10820	(24.1)
-3.0 m (-10 ft)	kg	*17270	*17270	*12430	10090	*9140	6590			*8390	6120	6.35
	lb	*38070	*38070	*27400	22240	*20150	14530			*18500	13490	(20.8)













1. Die Hublast richtet sich nach der Definition in SAE J1097 und ISO 10567.
2. Die Hublast der Serie ROBEX darf auf festem, ebenem Untergrund maximal 75 % der Kippplast der Maschine bzw. 87 % der gesamten hydraulischen Hubkraft betragen.

3. Der Lasthaken befindet sich an der Rückseite des Tieföffels.
4. (*) gibt die Lastbegrenzung durch die hydraulische Hubkraft an.













 Lastradius Frontauslage  Lastradius Seitenauslage bzw. 360 Grad

HX260 L HIGH WALKER

5,85 m (19' 2") Ausleger; 3,05 m (10' 0") Löffelstiel; 1,08 m³ Löffel (nach SAE gehäuft); 600 mm (24") 3-Stege-Bodenplatten.

Lasthöhe m (ft)	Lastradius										Max. Reichweite				
	1.5 m (5 ft)		3.0 m (10 ft)		4.5 m (15 ft)		6.0 m (20 ft)		7.5 m (25 ft)		Volumen		Reichweite m (ft)		
															
7.5 m (25 ft)	kg											*3930	*3930	6.92	
	lb											*8660	*8660	(22.7)	
6.0 m (20 ft)	kg							*5300	5290			*3740	*3740	7.87	
	lb							*11680	11660			*8250	*8250	(25.8)	
4.5 m (15 ft)	kg					*6800	*6800	*6240	5170			*3740	*3740	8.44	
	lb					*14990	*14990	*13760	11400			*8250	*8250	(27.7)	
3.0 m (10 ft)	kg				*10600	*10600	*8020	7020	*6830	5000			*3870	*3870	8.71
	lb				*23370	*23370	*17680	15480	*15060	11020			*8530	*8530	(28.6)
1.5 m (5 ft)	kg				*12730	10190	*9180	6670	*7460	4820			*4170	3850	8.72
	lb				*28060	22470	*20240	14700	*16450	10630			*9190	8490	(28.6)
Boden-niveau	kg			*7310	*7310	*13790	9860	*9960	6450	7330	4700	*4710	3970	8.45	
	lb			*16120	*16120	*30400	21740	*21960	14220	16160	10360	*10380	8750	(27.7)	
-1.5 m (-5 ft)	kg	*8200	*8200	*12390	*12390	*13860	9790	*10190	6370	7290	4660	*5660	4360	7.90	
	lb	*18080	*18080	*27320	*27320	*30560	21580	*22470	14040	16070	10270	*12480	9610	(25.9)	
-3.0 m (-10 ft)	kg	*13310	*13310	*18640	*18640	*12990	9900	*9610	6430			*7640	5240	6.98	
	lb	*29340	*29340	*41090	*41090	*28640	21830	*21190	14180			*16840	11550	(22.9)	
-4.5 m (-15 ft)	kg			*15000	*15000	*10610	10230					*8240	7600	5.50	
	lb			*33070	*33070	*23390	22550					*18170	16760	(18.0)	

5,85 m (19' 2") Ausleger; 3,60 m (11' 10") Löffelstiel; 1,08 m³ Löffel (nach SAE gehäuft); 600 mm (24") 3-Stege-Bodenplatten.

Lasthöhe m (ft)	Lastradius												Max. Reichweite				
	1.5 m (5 ft)		3.0 m (10 ft)		4.5 m (15 ft)		6.0 m (20 ft)		7.5 m (25 ft)		9.0 m (30 ft)		Volumen		Reichweite m (ft)		
																	
7.5 m (25 ft)	kg							*3630	*3630					*3410	*3410	7.56	
	lb							*8000	*8000					*7520	*7520	(24.8)	
6.0 m (20 ft)	kg							*5280	*5280					*3260	*3260	8.43	
	lb							*11640	*11640					*7190	*7190	(27.7)	
4.5 m (15 ft)	kg					*6110	*6110	*5710	5220					*3260	*3260	8.96	
	lb					*13470	*13470	*12590	11510					*7190	*7190	(29.4)	
3.0 m (10 ft)	kg				*9520	*9520	*7380	7090	*6370	5010	*4450	3730			*3370	*3370	9.22
	lb				*20990	*20990	*16270	15630	*14040	11050	*9810	8220			*7430	*7430	(30.3)
1.5 m (5 ft)	kg				*11910	10290	*8660	6690	*7080	4800	*4900	3630			*3610	3490	9.23
	lb				*26260	22690	*19090	14750	*15610	10580	*10800	8000			*7960	7690	(30.3)
Boden-niveau	kg			*7690	*7690	*13350	9830	*9610	6410	7280	4650			*4020	3580	8.98	
	lb			*16950	*16950	*29430	21670	*21190	14130	16050	10250			*8860	7890	(29.5)	
-1.5 m (-5 ft)	kg	*7250	*7250	*11420	*11420	*13790	9660	*10060	6280	7200	4570			*4740	3870	8.46	
	lb	*15980	*15980	*25180	*25180	*30400	21300	*22180	13850	15870	10080			*10450	8530	(27.8)	
-3.0 m (-10 ft)	kg	*11400	*11400	*16820	*16820	*13320	9710	*9830	6280	7250	4620			*6100	4530	7.61	
	lb	*25130	*25130	*37080	*37080	*29370	21410	*21670	13850	15980	10190			*13450	9990	(25.0)	
-4.5 m (-15 ft)	kg			*16730	*16730	*11640	9960	*8360	6480					*7750	6090	6.29	
	lb			*36880	*36880	*25660	21960	*18430	14290					*17090	13430	(20.6)	













1. Die Hublast richtet sich nach der Definition in SAE J1097 und ISO 10567.
2. Die Hublast der Serie ROBEX darf auf festem, ebenem Untergrund maximal 75 % der Kippplast der Maschine bzw. 87 % der gesamten hydraulischen Hubkraft betragen.

3. Der Lasthaken befindet sich an der Rückseite des Tieflöffels.
4. (*) gibt die Lastbegrenzung durch die hydraulische Hubkraft an.













 Lastradius Frontauslage  Lastradius Seitenauslage bzw. 360 Grad

HX260 L ZWEITEILIGER AUSLEGER

5,90 m (19' 4") Zweiteiliger Ausleger; 2,10 m (6' 11") Löffelstiel; 1,08 m³ Löffel (nach SAE gehäuft); 600 mm (24") 3-Steg-Bodenplatten.



Lasthöhe m (ft)		Lastradius										Max. Reichweite		
		3.0 m (10 ft)		4.5 m (15 ft)		6.0 m (20 ft)		7.5 m (25 ft)		9.0 m (30 ft)		Volumen		Reichweite m (ft)
														
9.0 m (30 ft)	kg lb											*12290 *27090	*12290 *27090	3.57 (11.7)
7.5 m (25 ft)	kg lb			*10100 *22270	*10100 *22270							*8890 *19600	7860 17330	5.70 (18.7)
6.0 m (20 ft)	kg lb			*10580 *23320	*10580 *23320	*8300 *18300	7250 15980					*7570 *16690	5700 12570	6.89 (22.6)
4.5 m (15 ft)	kg lb			*12620 *27820	10890 24010	*8850 *19510	6990 15410	*7080 *15610	4890 10780			*7020 *15480	4770 10520	7.60 (24.9)
3.0 m (10 ft)	kg lb					*9920 *21870	6630 14620	*7310 *16120	4770 10520			6670 14700	4330 9550	7.97 (26.1)
1.5 m (5 ft)	kg lb					10050 22160	6330 13960	7200 15870	4630 10210			6500 14330	4200 9260	8.04 (26.4)
Boden- niveau	kg lb					9870 21760	6160 13580	7110 15670	4560 10050			6720 14820	4320 9520	7.82 (25.6)
-1.5 m (-5 ft)	kg lb			*13180 *29060	9350 20610	9860 21740	6150 13560					7480 16490	4790 10560	7.28 (23.9)
-3.0 m (-10 ft)	kg lb													

5,90 m (19' 4") Zweiteiliger Ausleger; 2,50 m (8' 2") Löffelstiel; 1,08 m³ Löffel (nach SAE gehäuft); 600 mm (24") 3-Steg-Bodenplatten.

Lasthöhe m (ft)		Lastradius										Max. Reichweite		
		3.0 m (10 ft)		4.5 m (15 ft)		6.0 m (20 ft)		7.5 m (25 ft)		9.0 m (30 ft)		Volumen		Reichweite m (ft)
														
9.0 m (30 ft)	kg lb											*8650 *19070	*8650 *19070	4.28 (14.0)
7.5 m (25 ft)	kg lb			*8730 *19250	*8730 *19250	*7990 *17610	7370 16250					*7040 *15520	7000 15430	6.17 (20.2)
6.0 m (20 ft)	kg lb			*9110 *20080	*9110 *20080	*7910 *17440	7350 16200					*6500 *14330	5270 11620	7.28 (23.9)
4.5 m (15 ft)	kg lb			*11750 *25900	11100 24470	*8480 *18700	7070 15590	*6750 *14880	4950 10910			*6350 *14000	4470 9850	7.96 (26.1)
3.0 m (10 ft)	kg lb			*15300 *33730	10200 22490	*9520 *20990	6700 14770	*7060 *15560	4800 10580			6270 13820	4080 8990	8.31 (27.2)
1.5 m (5 ft)	kg lb			16100 35490	9530 21010	10100 22270	6360 14020	7200 15870	4630 10210			6110 13470	3950 8710	8.37 (27.5)
Boden- niveau	kg lb			*15730 *34680	9280 20460	9870 21760	6160 13580	7090 15630	4530 9990			6290 13870	4040 8910	8.16 (26.8)
-1.5 m (-5 ft)	kg lb	*11720 *25840	*11720 *25840	*13960 *30780	9280 20460	9810 21630	6100 13450	7090 15630	4530 9990			6910 15230	4430 9770	7.65 (25.1)
-3.0 m (-10 ft)	kg lb			*10930 *24100	9450 20830	*8340 *18390	6220 13710					*6510 *14350	5340 11770	6.76 (22.2)











1. Die Hublast richtet sich nach der Definition in SAE J1097 und ISO 10567.
2. Die Hublast der Serie ROBEX darf auf festem, ebenem Untergrund maximal 75 % der Kipplast der Maschine bzw. 87 % der gesamten hydraulischen Hubkraft betragen.

3. Der Lasthaken befindet sich an der Rückseite des Tieflöffels.
4. (*) gibt die Lastbegrenzung durch die hydraulische Hubkraft an.

 Lastradius Frontauslage  Lastradius Seitenauslage bzw. 360 Grad













HX260 L ZWEITEILIGER AUSLEGER

5,90 m (19' 4") Zweiteiliger Ausleger; 3,05 m (10' 0") Löffelstiel; 1,08 m³ Löffel (nach SAE gehäuft); 600 mm (24") 3-Step-Bodenplatten.

Lasthöhe m (ft)		Lastradius								Max. Reichweite		
		3.0 m (10 ft)		4.5 m (15 ft)		6.0 m (20 ft)		7.5 m (25 ft)		Volumen		Reichweite m (ft)
												
9.0 m (30 ft)	kg lb			*7440 *16400	*7440 *16400					*5450 *12020	*5450 *12020	5.21 (17.1)
7.5 m (25 ft)	kg lb					*7160 *15790	*7160 *15790			*4640 *10230	*4640 *10230	6.84 (22.4)
6.0 m (20 ft)	kg lb			*7950 *17530	*7950 *17530	*7410 *16340	*7410 *16340	*6160 *13580	5100 11240	*4330 *9550	*4330 *9550	7.86 (25.8)
4.5 m (15 ft)	kg lb	*14560 *32100	*14560 *32100	*9800 *21610	*9800 *21610	*7950 *17530	7170 15810	*6350 *14000	5000 11020	*4240 *9350	4020 8860	8.48 (27.8)
3.0 m (10 ft)	kg lb			*13840 *30510	10440 23020	*8930 *19690	6770 14930	*6710 *14790	4810 10600	*4320 *9520	3700 8160	8.81 (28.9)
1.5 m (5 ft)	kg lb			*16000 *35270	9650 21270	10140 22350	6390 14090	*7180 *15830	4620 10190	*4560 *10050	3580 7890	8.87 (29.1)
Boden- niveau	kg lb			15780 34790	9250 20390	9840 21690	6130 13510	7040 15520	4480 9880	*5000 *11020	3650 8050	8.68 (28.5)
-1.5 m (-5 ft)	kg lb	*11670 *25730	*11670 *25730	*14760 *32540	9160 20190	9720 21430	6020 13270	6980 15390	4430 9770	*5790 *12760	3940 8690	8.20 (26.9)
-3.0 m (-10 ft)	kg lb			*12240 *26980	9260 20410	*9360 *20640	6070 13380			*6510 *14350	4620 10190	7.38 (24.2)

HX260 NL ZWEITEILIGER AUSLEGER

5,90 m (19' 4") Zweiteiliger Ausleger; 2,10 m (6' 11") Löffelstiel; 1,08 m³ Löffel (nach SAE gehäuft); 600 mm (24") 3-Step-Bodenplatten.

Lasthöhe m (ft)		Lastradius										Max. Reichweite		
		3.0 m (10 ft)		4.5 m (15 ft)		6.0 m (20 ft)		7.5 m (25 ft)		9.0 m (30 ft)		Volumen		Reichweite m (ft)
														
9.0 m (30 ft)	kg lb											*12470 *27490	*12470 *27490	3.48 (11.4)
7.5 m (25 ft)	kg lb			*10110 *22290	*10110 *22290							*8940 *19710	7300 16090	5.66 (18.6)
6.0 m (20 ft)	kg lb			*10550 *23260	*10550 *23260	*8300 *18300	6660 14680					*7590 *16730	5260 11600	6.87 (22.5)
4.5 m (15 ft)	kg lb			*12540 *27650	9930 21890	*8830 *19470	6400 14110	*7080 *15610	4480 9880			*7030 *15500	4380 9660	7.59 (24.9)
3.0 m (10 ft)	kg lb					*9890 *21800	6050 13340	*7300 *16090	4360 9610			6660 14680	3960 8730	7.96 (26.1)
1.5 m (5 ft)	kg lb					10020 22090	5750 12680	7170 15810	4220 9300			6470 14260	3820 8420	8.04 (26.4)
Boden- niveau	kg lb					9830 21670	5590 12320	7090 15630	4150 9150			6680 14730	3930 8660	7.83 (25.7)
-1.5 m (-5 ft)	kg lb			*13250 *29210	8400 18520	9820 21650	5580 12300					7420 16360	4340 9570	7.30 (23.9)
-3.0 m (-10 ft)	kg lb					*7380 *16270	5750 12680							













1. Die Hublast richtet sich nach der Definition in SAE J1097 und ISO 10567.
2. Die Hublast der Serie ROBEX darf auf festem, ebenem Untergrund maximal 75 % der Kipplast der Maschine bzw. 87 % der gesamten hydraulischen Hubkraft betragen.

3. Der Lasthaken befindet sich an der Rückseite des Tieflöffels.
4. (*) gibt die Lastbegrenzung durch die hydraulische Hubkraft an.













 Lastradius Frontauslage  Lastradius Seitenauslage bzw. 360 Grad

HX260 NL ZWEITEILIGER AUSLEGER

5,90 m (19' 4") Zweiteiliger Ausleger; 2,50 m (8' 2") Löffelstiel; 1,08 m³ Löffel (nach SAE gehäuft); 600 mm (24") 3-Steg-Bodenplatten.

Lasthöhe m (ft)		Lastradius								Max. Reichweite				
		3.0 m (10 ft)		4.5 m (15 ft)		6.0 m (20 ft)		7.5 m (25 ft)		9.0 m (30 ft)		Volumen	Reichweite	
														m (ft)
9.0 m (30 ft)	kg lb											*8730 *19250	*8730 *19250	4.21 (13.8)
7.5 m (25 ft)	kg lb			*8740 *19270	*8740 *19270	*7950 *17530	6760 14900					*7070 *15590	6490 14310	6.13 (20.1)
6.0 m (20 ft)	kg lb			*9070 *20000	*9070 *20000	*7910 *17440	6750 14880					*6500 *14330	4860 10710	7.26 (23.8)
4.5 m (15 ft)	kg lb			*11670 *25730	10130 22330	*8450 *18630	6490 14310	*6740 *14860	4530 9990			*6350 *14000	4100 9040	7.94 (26.1)
3.0 m (10 ft)	kg lb			*15250 *33620	9250 20390	*9480 *20900	6120 13490	*7050 *15540	4380 9660			6260 13800	3720 8200	8.30 (27.2)
1.5 m (5 ft)	kg lb			16060 35410	8600 18960	10070 22200	5790 12760	7180 15830	4220 9300			6090 13430	3590 7910	8.37 (27.5)
Boden- niveau	kg lb			15740 34700	8340 18390	9830 21670	5580 12300	7060 15560	4120 9080			6250 13780	3670 8090	8.17 (26.8)
-1.5 m (-5 ft)	kg lb	*11470 *25290	*11470 *25290	*14030 *30930	8330 18360	9770 21540	5530 12190	7060 15560	4120 9080			6860 15120	4010 8840	7.66 (25.1)
-3.0 m (-10 ft)	kg lb			*11040 *24340	8500 18740	*8440 *18610	5640 12430					*6550 *14440	4820 10630	6.79 (22.3)

5,90 m (19' 4") Zweiteiliger Ausleger; 3,05 m (10' 00") Löffelstiel; 1,08 m³ Löffel (nach SAE gehäuft); 600 mm (24") 3-Steg-Bodenplatten.

Lasthöhe m (ft)		Lastradius								Max. Reichweite				
		3.0 m (10 ft)		4.5 m (15 ft)		6.0 m (20 ft)		7.5 m (25 ft)		9.0 m (30 ft)		Volumen	Reichweite	
														m (ft)
9.0 m (30 ft)	kg lb			*7380 *16270	*7380 *16270							*5490 *12100	*5490 *12100	5.15 (16.9)
7.5 m (25 ft)	kg lb					*7110 *15670	6950 15320					*4650 *10250	*4650 *10250	6.81 (22.3)
6.0 m (20 ft)	kg lb			*7920 *17460	*7920 *17460	*7400 *16310	6870 15150	*6080 *13400	4680 10320			*4330 *9550	4300 9480	7.83 (25.7)
4.5 m (15 ft)	kg lb	*13630 *30050	*13630 *30050	*9620 *21210	*9620 *21210	*7930 *17480	6580 14510	*6350 *14000	4580 10100			*4240 *9350	3690 8140	8.47 (27.8)
3.0 m (10 ft)	kg lb			*13720 *30250	9490 20920	*8890 *19600	6190 13650	*6700 *14770	4400 9700			*4320 *9520	3370 7430	8.81 (28.9)
1.5 m (5 ft)	kg lb			*15980 *35230	8710 19200	10110 22290	5810 12810	*7160 *15790	4210 9280			*4550 *10030	3250 7170	8.88 (29.1)
Boden- niveau	kg lb			15730 34680	8310 18320	9810 21630	5550 12240	7010 15450	4070 8970			*4990 *11000	3310 7300	8.68 (28.5)
-1.5 m (-5 ft)	kg lb	*11500 *25350	*11500 *25350	*14820 *32670	8220 18120	9690 21360	5440 11990	6950 15320	4010 8840			*5760 *12700	3570 7870	8.21 (26.9)
-3.0 m (-10 ft)	kg lb			*12330 *27180	8310 18320	*9430 *20790	5490 12100					*6540 *14420	4170 9190	7.41 (24.3)

1. Die Hublast richtet sich nach der Definition in SAE J1097 und ISO 10567.
2. Die Hublast der Serie ROBEX darf auf festem, ebenem Untergrund maximal 75 % der Kipplast der Maschine bzw. 87 % der gesamten hydraulischen Hubkraft betragen.

3. Der Lasthaken befindet sich an der Rückseite des Tieflöffels.
4. (*) gibt die Lastbegrenzung durch die hydraulische Hubkraft an.

MOTOR	STD	OPT
Cummins-Motor QSB 6.7	●	
HYDRAULIKSYSTEM		
IPC (Intelligent Power Control)		
3 Leistungsstufen, 2 Arbeitsarten, Benutzermodus	●	
Variable Leistungssteuerung	●	
Pumpenfördermengenregelung	●	
Volumenstromregelung für Anbaugerät-Betriebsart		●
Automatischer Motorleerlauf	●	
Automatische Motorabschaltung		●
Elektronische Gebläsesteuerung	●	
KABINE UND INNENRAUM		
Kabine nach ISO-Norm		
Obenrunder Frontscheibenwischer	●	
Radio/USB-Player	●	
Mobiltelefon-Freisprecheinrichtung mit USB	●	
12-Volt-Steckdose (Wandler 24 VDC auf 12 VDC)	●	
Elektrisches Signalhorn	●	
Allwetter-Stahlkabine mit 360°-Rundsicht	●	
Sicherheitsglasscheiben	●	
Frontscheibe einschiebbar	●	
Seitenscheibe (links) als Schiebefenster	●	
Abschließbare Tür	●	
Warmhalte- und Kühlbox	●	
Aufbewahrungsfach und Aschenbecher	●	
Kabinendachabdeckung transparent	●	
Sonnenblende	●	
Tür- und Kabinenschlösser, ein Schlüssel	●	
Mechanisch gefederter, beheizter Sitz	●	
Vorsteuerdruckunterstützter Joystick	●	
Konsole höhenverstellbar	●	
Automatische Klimaregelung		
Klimaanlage und Heizung	●	
Scheibenheizung	●	
Starthilfe (Ansaugluftvorwärmung) bei kalten Temperaturen	●	
Zentrale Überwachung		
8-Zoll-LCD	●	
Motordrehzahl oder Tageszähler/Beschleunigung	●	
Motor Kühlmittel-Temperaturanzeige	●	
Max. Leistung	●	
Kriechgang/Schnellgang	●	
Automatischer Leerlauf	●	
Überlast	●	
Motor überprüfen	●	
Luftfilter verstopft	●	
Anzeigen	●	
ÖKO-Anzeigen	●	
Kraftstoffstandanzeige	●	
Anzeige für die Hydrauliköltemperatur	●	
Kraftstoffvorwärmer	●	
Warnungen	●	
Kommunikationsfehler	●	
Batterie niedrig	●	
Uhr	●	
Kabinenscheinwerfer		●
Regenschutz für Kabinenfrontfenster		●
Kabinendachabdeckung in Stahl		●
Sitz		
Einstellbarer Fahrersitz mit Luftfederung und Heizung		●
Kabinen-FOPS/FOG (ISO/DIN 10262) Stufe 2		
FOPS (Schutzeinrichtung gegen herabfallende Gegenstände) - ISO 3449 Stufe 2		●
FOG (Schutzaufbau gegen herabfallende Gegenstände)		●
Kabinen-ROPS (ISO 12117-2)		
ROPS (Überrollschutz)	●	

SICHERHEIT	STD	OPT
Batterie Hauptschalter	●	
Heckkamera	●	
Kameragestützte virtuelle Draufsicht incl. Bewegobjektüberwachung (AAVM + MOD)		●
Vier Arbeitsscheinwerfer	●	
Fahralarm	●	
Arbeitsscheinwerfer hinten	●	
Rundumleuchte		●
Automatische Schwenkbremse	●	
Auslegerhaltesystem	●	
Stielhaltesystem	●	
Sicherheitsventil für Auslegerzylinder mit Überlastwarneinrichtung	●	
Sicherheitsventil für Löffelstielzylinder		●
Schwenksperre		●
Drei Außenrückspiegel	●	
SONSTIGES		
Ausleger		
5,85 m; 19' 2" Ausleger	●	
5,90 m; 19' 4" Zweiteiliger Ausleger		●
Löffelstiel		
2,1 m; 6' 11"		●
2,5 m; 8' 2"		●
3,05 m; 10' 0"	●	
3,60 m; 11' 10"		●
Herausnehmbares Kühlerstaubgitter	●	
Herausnehmbarer Vorratsbehälter	●	
Kraftstoffvorfilter	●	
Kraftstoffvorwärmer einfach	●	
Kraftstoffvorwärmer zweifach		●
Selbstdiagnosesystem	●	
Hi-mate (Maschinenmanagementsystem)	●	
Batterien (2 x 12 V x 100 Ah)	●	
Kraftstoffbetankungspumpe (50 l/min)	●	
Einfach wirkende Verrohrung (Hydraulikhammer usw.)		●
Doppelt wirkende Verrohrung (Zweischalengreifer usw.)	●	
Verrohrung für drehende Anbaugeräte		●
Verrohrung für hydraulische Schnellwechsler		●
Schnellwechsler		●
Auslegerschwimmsteuerung		●
Einpedal-Geradeausfahrt		●
Druckspeicher beim Senken der Arbeitseinrichtung	●	
Bedienschema-Umschaltventil (2 Muster)		●
Feinsteuerung Schwenken		●
Werkzeugsatz		●
UNTERWAGEN		
Unterbodenschutz Unterwagen (extra)	●	
Unterbodenschutz Unterwagen (normal)	●	
Bodenplatten		
3-Steg-Bodenplatten (600 mm; 24")	●	
3-Steg-Bodenplatten (700 mm; 28")		●
3-Steg-Bodenplatten (800 mm; 32")		●
3-Steg-Bodenplatten (900 mm; 36")		●
2-Steg-Bodenplatten (700 mm; 28")		●
Laufrollenschutz	●	
Laufrollenschutz "High Walker"		●
DREHKRANZ		
Drehkranz	●	
Drehkranz (High Walker)		●

STD = Standard
OPT = Optional

- * Standard- und Wahlausstattung können je nach Modell abweichen. Weitere Informationen erhalten Sie von Ihrem Hyundai-Händler. Die Maschinenausstattung kann von internationalen Normen abhängig sein.
- * Auf den Fotos können Anbauten und optionale Geräte abgebildet sein, die in Ihrer Region nicht erhältlich sind.
- * Änderungen der Materialien und technischen Daten vorbehalten.
- * Alle Maße in angloamerikanischen Maßeinheiten sind auf das nächste volle Maß (Pound oder Zoll) gerundet