

MOTOR		
Hersteller / Modell	Scania DC13 084A	
Typ	Turboaufgeladener 4-Takt-Dieselmotor mit Ladeluftkühlung	
Nennleistung am Schwungrad	SAE J1995 (brutto)	331 kW (444 PS) bei 1900 U/min
	SAE J1349 (netto)	316 kW (424 PS) bei 1900 U/min
	DIN 6271/1 (brutto)	331 kW (450 PS) bei 1900 U/min
	DIN 6271/1 (netto)	316 kW (430 PS) bei 1900 U/min
Höchstdrehmoment	232 kgf·m (1.678 lbf·ft) bei 1250 U/min	
Bohrung × Hub	130 × 160 mm (5.12" × 6.3")	
Hubraum	12700 cc (775 Kubikzoll)	
Batterien	24 V × 200 Ah	
Anlasser	24 V × 6 kW	
Generator	24 V × 100 A	

HYDRAULIKSYSTEM	
HAUPTPUMPE	
Typ	Verstellbare Axialkolbenpumpen in Tandemausführung
Maximaler Durchfluss	2 × 380 l/min (100,4 U.S. gpm / 83,6 U.K. gpm)
Hilfspumpe für Vorsteuerkreis	Zahnradpumpe

Quererfassendes und kraftstoffsparendes Pumpensystem

HYDRAULIKMOTOREN	
Fahren	Axialkolbenmotor mit zwei Geschwindigkeiten mit Bremsventil und Parkbremse
Schwenken	Axialkolbenmotor mit automatischer Bremse
ÜBERDRUCKVENTILEINSTELLUNG	
Anbaugerätkreise	330 kgf/cm <sup>2</sup> (4690 psi)
Fahren	330 kgf/cm <sup>2</sup> (4690 psi)
Leistungsstufe (Ausleger, Löffelstiel, Löffel)	360 kgf/cm <sup>2</sup> (5120 psi)
Schwenkkreis	285 kgf/cm <sup>2</sup> (4050 psi)
Vorsteuerkreis	40 kgf/cm <sup>2</sup> (569 psi)
Serviceventil	Installiert

HYDRAULIKZYLINDER	
Zylinder: Bohrung × Hub	Ausleger: Ø 170 × 1570 mm Löffelstiel: Ø 190 × 1820 mm Tiefelöffel: Ø 170 × 1370 mm

ANTRIEBE UND BREMSEN	
Antriebsart	Vollhydrostatisch
Antriebsmotor	Axialkolbenmotor, mit Bremse integriert
Untersetzung	Planetenuntersetzungsgetriebe
Max. Zugkraft	34100 kgf (75,180 lbf)
Max. Fahrgeschwindigkeit (Schnell-/Langsamgang)	5,3 km/h (3,29 mph) / 3,3 km/h (2,05 mph)
Steigfähigkeit	35° (70%)
Handbremse	Mehrscheibenausführung, nass

STEUERUNG	
Vorsteuerdruckunterstützte Joysticks und Pedale mit abnehmbarem Hebel für nahezu kraft- und ermüdungsfreie Bedienung.	
Vorsteuerung	Zwei Joysticks mit einem Sicherheitshebel (links): Schwenken und Löffelstiel (rechts): Ausleger und Tiefelöffel (ISO)
Fahren und Lenken	Zwei Hebel mit Pedalen
Motordrossel	Elektrisch, als Drehregler ausgeführt

SCHWENKWERK	
Schwenkmotor	Axialkolbenmotor mit festem Schluckvolumen
Schwenkuntersetzung	Planetenraduntersetzung
Drehkranzschmierung	Fettbad
Schwenkbremse	Mehrscheibenausführung, nass
Schwenkgeschwindigkeit	8,6 U/min

SERVICE-FÜLLMENGEN			
Nachfüllmenge	Liter	US gal	UK gal
Kraftstofftank	610	161.1	134.2
Motorkühlmittel	50	13.2	11
Motoröl	39	10.3	8.6
Schwenkeinrichtung	7	1.8	1.54
Endantrieb (je)	12	3.2	2.64
Hydrauliksystem (einschl. Behälter)	486	128.4	105.9
Hydraulikölbehälter	262	69.2	57.6
DEF/AdBlue®	69	18.2	15.2

UNTERWAGEN	
Der X-Mittelrahmen ist eine vollverschweißte Konstruktion mit verstärkten Kastenrahmen für das Laufwerk. Der Unterwagen ist mit geschmierten Rollen, Leiträdern, Kettenspannern mit stoßdämpfenden Federn und Antriebsrädern sowie Raupenkettenspannern mit 2- oder 3-Steg-Bodenplatten ausgerüstet.	
Mittelrahmen	X-Rahmen
Unterwagen	Fünfeckiges Kastenprofil
Kettenplatten pro Seite	53 je
Stützrollen pro Seite	3 je
Laufrollen pro Seite	9 je
Kettenführungen pro Seite	2 je

BETRIEBSGEWICHT (CIRCA)	
Betriebsgewicht, einschliesslich 6250 mm (20' 6") Ausleger; 3050 mm (10' 0") Löffelstiel; 1,27 m <sup>3</sup> (1.66 yd <sup>3</sup> ) Löffel gehäuft nach SAE, Schmiermittel, Kühlmittel, vollem Kraftstofftank, vollem Hydraulikölbehälter und aller Standardausrüstung.	

BETRIEBSGEWICHT					
Platten	Typ	Breite mm (in)	Betriebsgewicht		Bodendruck kgf/cm <sup>2</sup> (psi)
			HX520 L	kg (lb)	
Dreisteg	600 (24")	HX520 L	52400 (115,520)	0,91 (12,94)	
	700 (28")	HX520 L	52920 (116,670)	0,79 (11,23)	
	800 (32")	HX520 L	53180 (117,240)	0,74 (10,52)	
Doppelsteg	600 (24")	HX520 L	52215 (115,110)	0,91 (12,94)	
	700 (28")	HX520 L	52735 (116,260)	0,78 (11,09)	
Hohe Beanspruchung Steg	600 (24")	HX520 HD	52580 (115,920)	0,91 (12,94)	
	700 (28")	HX520 HD	53130 (117,130)	0,79 (11,2)	

# AUSWAHLHILFE BAGGERLÖFFEL UND SCHACHTKRAFT

# HX520 L

## LÖFFEL

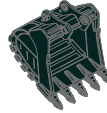
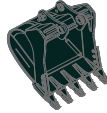
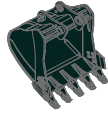

gehäuft nach SAE  
m<sup>3</sup> (yd<sup>3</sup>)

1,00 (1.31)  
1,38 (1.8)  
2,20 (2.88)  
2,79 (3.65)  
3,00 (3.92)

◆ 2,20 (2.88)  
◆ 2,43 (3.18)  
◆ 2,79 (3.65)  
◆ 3,20 (4.19)

◆ 2,20 (2.88)  
◆ 2,43 (3.18)  
◆ 2,79 (3.65)  
◆ 3,20 (4.19)

◆ 1,81 (2.37)

◆ 2,70 (3.53)  
◆ 3,00 (3.92)

Inhalt m <sup>3</sup> (yd <sup>3</sup> )		Breite mm (in)	Gewicht kg (lb)	Empfehlung mm (ft.in)						
gehäuft nach SAE	gehäuft nach CECE			6550 (21' 6") Ausleger		7060 (23' 2") Ausleger			9000 (29' 6") Ausleger	
				2400 (7' 10") Löffelstiel	2900 (9' 6") Löffelstiel	2400 (7' 10") Löffelstiel	2900 (9' 6") Löffelstiel	3380 (11' 1") Löffelstiel	4000 (7' 10") Löffelstiel	6000 (19' 8") Löffelstiel
1,00 (1.31)	0,90 (1.18)	1030 (41")	1450 (3,200)	●	●	●	●	●	●	●
1,38 (1.8)	1,24 (1.62)	1215 (48")	1670 (3,680)	●	●	●	●	●	●	○
2,20 (2.88)	1,93 (2.52)	1685 (66")	2030 (4,480)	●	●	●	●	●	●	-
2,79 (3.65)	2,47 (3.23)	1865 (73")	2300 (5,070)	●	●	●	⊙	⊙	⊙	-
3,00 (3.92)	2,70 (3.53)	1985 (78")	2440 (5,380)	●	●	⊙	⊙	⊙	○	-
◆ 2,20 (2.88)	1,93 (2.52)	1685 (66")	2320 (5,110)	●	●	●	●	●	●	-
◆ 2,43 (3.18)	2,11 (2.76)	1830 (72")	2450 (5,400)	●	●	●	●	●	⊙	-
◆ 2,79 (3.65)	2,47 (3.23)	1865 (73")	2630 (5,800)	●	●	●	⊙	⊙	○	-
◆ 3,20 (4.19)	2,82 (3.69)	2075 (82")	2870 (6,330)	⊙	⊙	⊙	○	○	○	-
◆ 1,81 (2.37)	1,50 (1.96)	1540 (61")	2650 (5,840)	●	●	●	●	●	-	-
◆ 2,20 (2.88)	1,93 (2.52)	1685 (66")	2610 (5,750)	●	●	●	●	●	-	-
◆ 2,43 (3.18)	2,11 (2.76)	1830 (72")	2730 (6,020)	●	●	●	●	⊙	-	-
◆ 2,79 (3.65)	2,47 (3.23)	1865 (73")	2950 (6,500)	●	⊙	⊙	⊙	⊙	-	-
◆ 3,20 (4.19)	2,82 (3.69)	2075 (82")	3230 (7,120)	⊙	⊙	○	○	○	-	-
◆ 2,70 (3.53)	2,39 (3.13)	1800 (71")	2770 (6,110)	●	●	●	⊙	⊙	-	-
◆ 3,00 (3.92)	2,76 (3.61)	1995 (79")	3040 (6,700)	⊙	⊙	⊙	○	○	-	-

◆ Tieflöffel für hohe Beanspruchung  
◆ Felslöffel für hohe Beanspruchung

● : Für Material mit einer Dichte von maximal 2000 kg /m<sup>3</sup> (3370 lb/ yd<sup>3</sup>)  
⊙ : Für Material mit einer Dichte von maximal 1600 kg /m<sup>3</sup> (2700 lb/ yd<sup>3</sup>)  
○ : Für Material mit einer Dichte von maximal 1100 kg /m<sup>3</sup> (1850 lb/ yd<sup>3</sup>)

## ANBAUGERÄT

Ausleger und Löffelstiel sind als verschweißtes, spannungsarmes Kastenprofil ausgeführt.

Erhältlich: Ausleger in 6,55 m (21' 6"); 7,06 m (23' 2") und 9,0 m (29' 6") und Löffelstiel in 2,4 m (7' 10"); 2,9 m (9' 6"); 3,38 m (11' 1"); 4,0 m (7' 10") und 6,0 m (19' 8").

## SCHACHTKRAFT

Ausleger	Länge mm (ft.in)	mm (ft.in)	6550 (21' 6")		7060 (23' 2")			9000 (29' 6")	Anmer- kungen:
			kg (lb)	4340 (9,570)	4370 (9,630)			5130 (11,310)	
Löffelstiel	Länge mm (ft.in)	mm (ft.in)	2400 (7' 10")	2900 (9' 6")	2400 (7' 10")	2900 (9' 6")	3380 (11' 1")	4000 (13' 1")	6000 (19' 8")
			Gewicht kg (lb)	2430 (5,360)	2630 (5,800)	2430 (5,360)	2630 (5,800)	2670 (5,890)	2760 (6,080)
Tieflöffel Losbrech- kraft	SAE	kN	241,2 [263,2]	241,2 [263,2]	241,2 [263,2]	241,2 [263,2]	241,2 [263,2]	241,2 [263,2]	184,4
		kgf	24600 [26840]	24600 [26840]	24600 [26840]	24600 [26840]	24600 [26840]	24600 [26840]	18800
		lbf	54230 [59170]	54230 [59170]	54230 [59170]	54230 [59170]	54230 [59170]	54230 [59170]	41450
	ISO	kN	280,5 [306,0]	280,5 [306,0]	280,5 [306,0]	280,5 [306,0]	280,5 [306,0]	280,5 [306,0]	213,8
		kgf	28600 [31200]	28600 [31200]	28600 [31200]	28600 [31200]	28600 [31200]	28600 [31200]	21800
		lbf	63050 [68780]	63050 [68780]	63050 [68780]	63050 [68780]	63050 [68780]	63050 [68780]	48060
Tieflöf- felstiel Reißkraft	SAE	kN	278,5 [303,8]	225,6 [246,1]	278,5 [303,8]	225,6 [246,1]	192,2 [209,7]	171,6 [187,2]	103,0
		kgf	28400 [30980]	23000 [25090]	28400 [30980]	23000 [25090]	19600 [21380]	17500 [19090]	10500
		lbf	62610 [68300]	50710 [55310]	62610 [68300]	50710 [55310]	43210 [47130]	38580 [42090]	23150
	ISO	kN	291,3 [317,7]	235,4 [256,7]	291,3 [317,7]	235,4 [256,7]	200,1 [218,2]	177,5 [193,7]	105,9
		kgf	29700 [32400]	24000 [26180]	29700 [32400]	24000 [26180]	20400 [22250]	18100 [19750]	10800
		lbf	65480 [71430]	52910 [57720]	65480 [71430]	52910 [57720]	44970 [49050]	39900 [43540]	23810

Hinweis : Auslegergewicht inklusive Stielzylinder, Verrohrung und Bolzen.  
Stielgewicht inklusive Löffelzylinder, Verbindungsstangen und Bolzen.

# MASSE UND ARBEITSBEREICH

# HX520 L

## HX520 L

Ausleger in 6,55 m (21' 6"); 7,06 m (23' 2") und 9,0 m (29' 6") und Löffelstiel in 2,4 m (7' 10"); 2,9 m (9' 6"); 3,38 m (11' 1"); 4,09 m (13' 1") und 6,0 m (19' 8")

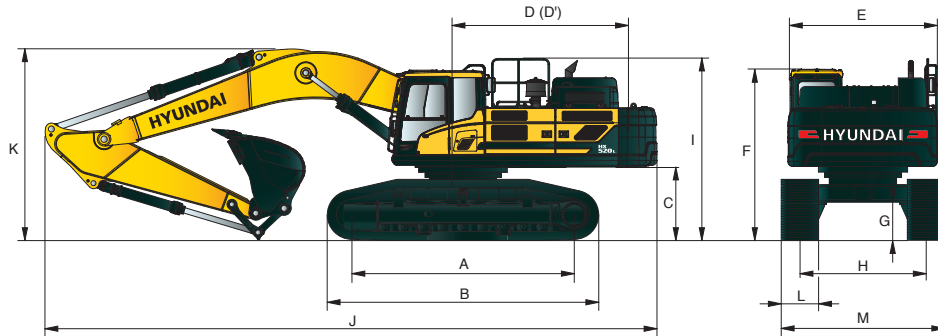

Einheit : mm (ft-in)

A	Aufstandslänge	4470 (14' 8")
B	Gesamtlänge der Raupe	5460 (17' 11")
C	Bodenfreiheit des Heckgegengewichts	1445 (4' 9")
D	Heckschwenkradius	3940 (12' 11")
D'	Hecklänge	3885 (12' 9")
E	Gesamtbreite des Oberwagens	2980 (9' 9")
F	Gesamthöhe der Kabine	3340 (10' 11")
G	Mindest-Bodenfreiheit	770 (2' 6")
H	Spurweite	Extended 2940 (9' 8") Eingefahren 2380 (7' 10")
I	Gesamthöhe des Schutzgeländers	3595 (11' 8")

	6550 (21' 6")		7060 (23' 2")			9000 (29' 6")		
	Auslegerlänge	6550 (21' 6")	7060 (23' 2")	9000 (29' 6")				
Löffelstiellänge	2400 (7' 10")	2900 (9' 6")	2400 (7' 10")	2900 (9' 6")	3380 (11' 1")	4000 (13' 8")	6000 (19' 8")	
	12000 (39' 4")	11870 (38' 11")	12510 (41' 1")	12380 (40' 7")	12260 (40' 3")	12250 (40' 2")	14200 (46' 7")	
	J Gesamtlänge	4190 (13' 9")	4080 (13' 5")	4070 (13' 4")	3920 (12' 10")	3790 (12' 5")	4090 (13' 5")	3960 (13' 0")
		K Gesamthöhe des Auslegers	600 (24")	700 (28")	750 (30")	800 (32")		
L Breite der Bodenplatten	3540 (11' 7")	3640 (11' 11")	3690 (12' 1")	3740 (12' 3")				
	M Gesamtbreite	2980 (9' 10")	3080 (10' 1")	3130 (10' 3")	3180 (10' 5")			
	Verlängert							
	Eingefahren							

## ARBEITSBEREICH HX520 L

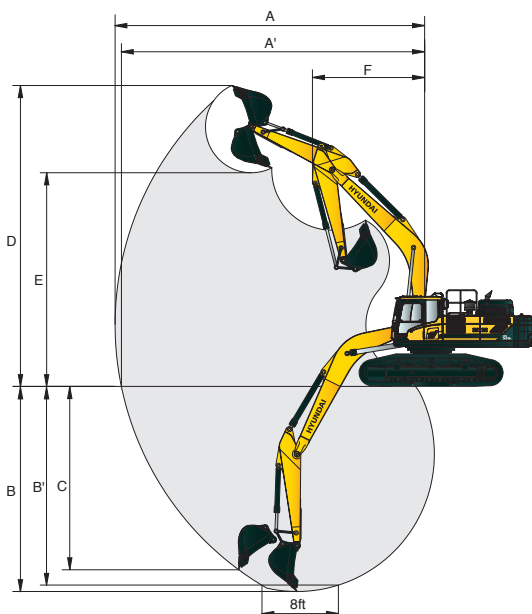











Einheit : mm (ft-in)

	6550 (21' 6")		7060 (23' 2")			9000 (29' 6")		
	Auslegerlänge	6550 (21' 6")	7060 (23' 2")	9000 (29' 6")				
Löffelstiellänge	2400 (7' 10")	2900 (9' 6")	2400 (7' 10")	2900 (9' 6")	3380 (11' 1")	4000 (13' 1")	6000 (19' 8")	
	10690 (35' 1")	11130 (36' 6")	11200 (36' 9")	11620 (38' 1")	12040 (39' 6")	12600 (41' 4")	16180 (53' 1")	
	A Max. Schachtweite	10430 (34' 3")	10870 (35' 8")	10950 (35' 11")	11380 (37' 4")	11810 (38' 9")	12380 (40' 7")	16010 (52' 6")
		B Max. Schachttiefe	6240 (20' 6")	6740 (22' 1")	6630 (21' 9")	7130 (23' 5")	7610 (25' 0")	8230 (27' 0")
B' Max. Schachttiefe (auf ca. 2,40 m)	6060 (19' 11")	6580 (21' 7")	6460 (21' 2")	6980 (22' 11")	7470 (24' 6")	8110 (26' 7")	11770 (38' 7")	
	C Max. vertikale Abstehtiefe	4370 (14' 4")	5420 (17' 9")	4650 (15' 3")	5660 (18' 7")	5770 (18' 11")	6320 (20' 9")	8360 (27' 5")
D Max. Einstechhöhe	10390 (34' 1")	10660 (35' 0")	10750 (35' 3")	10980 (36' 0")	11060 (36' 3")	11280 (37' 0")	12590 (41' 4")	
	E Max. Ladehöhe	7040 (23' 1")	7210 (23' 8")	7410 (24' 4")	7540 (24' 9")	7690 (25' 3")	7910 (25' 11")	9410 (30' 10")
F Min. Frontschwenkradius	4870 (16' 0")	4540 (14' 11")	5160 (16' 11")	4890 (16' 1")	4850 (15' 11")	4710 (15' 5")	6140 (20' 2")	













 Lastradius Frontauslage  Lastradius Seitenauslage bzw. 360 Grad

## HX520 L

6,55 m (21' 6") Ausleger; 2,40 m (7' 10") Löffelstiel; 0,92 m<sup>3</sup> Löffel (nach SAE gehäuft); 600 mm (24") 3-Steg-Bodenplatten

Lasthöhe m (ft)	Lastradius								Max. Reichweite			
	3.0 m (10 ft)		4.5 m (15 ft)		6.0 m (20 ft)		7.5 m (25 ft)		Volumen		Reichweite m (ft)	
												
6.0 m (20 ft)	kg					*13290	*13290	*12630	11600	*11270	7540	9.8
	lb					*29290	*29290	*27840	25560	*24840	16610	32.02
4.5 m (15 ft)	kg		*19010	*19010	*15250	*15250	*13520	11190	10630	6840	10.22	
	lb		*41910	*41910	*33630	*33630	*29820	24660	23430	15070	33.39	
3.0 m (10 ft)	kg				*17320	15170	*14580	10730	10240	6540	10.36	
	lb				*38170	33450	*32140	23650	22560	14410	33.86	
1.5 m (5 ft)	kg				*18760	14520	*15410	10350	10320	6560	10.25	
	lb				*41370	32000	*333970	22810	22740	14460	33.48	
Boden-niveau	kg		*24850	22470	*19270	14170	*15740	10110	10920	6943	9.86	
	lb		*54790	49530	*42470	31240	*34690	22290	24080	15310	32.22	
-1.5 m (-5 ft)	kg	*26490	*26490	*23670	22520	*18780	14100	*15300	10070	*11680	7850	9.17
	lb	*58390	*58390	*52180	49650	*41440	31090	*33740	22210	*25740	17300	29.95
-3.0 m (-10 ft)	kg	*26910	*26910	*21450	*21450	*17220	14290			*11150	9790	8.05
	lb	*59330	*59330	*47290	*47290	*37970	31510			*24580	21590	26.31
-4.5 m (-15 ft)	kg			*17540	*17540					*10720	*10720	7.49
	lb			*38660	*38660					*23640	*23640	24.46

6,55 m (21' 6") Ausleger; 2,90 m (9' 6") Löffelstiel 0,92 m<sup>3</sup> Löffel (nach SAE gehäuft); 600 mm (24") 3-Steg-Bodenplatten

Lasthöhe m (ft)	Lastradius										Max. Reichweite		
	3.0 m (10 ft)		4.5 m (15 ft)		6.0 m (20 ft)		7.5 m (25 ft)		9.0 m (30 ft)		Volumen		Reichweite m (ft)
													
7.5 m (25 ft)	kg						*11640	*11640			*8710	8100	9.54
	lb						*25650	*25650			*19200	17850	31.17
6.0 m (20 ft)	kg						*12110	11690			*8690	6970	10.24
	lb						*26700	25770			*19170	15360	33.44
4.5 m (15 ft)	kg		*17530	*17530	*14570	*14570	*13130	11250			*8810	6340	10.63
	lb		*38640	*38640	*32110	*32110	*28940	24800			*19410	13990	34.73
3.0 m (10 ft)	kg		*22060	*22060	*16800	15320	*14310	10750	12550	7950	*9040	6060	10.77
	lb		*48640	*48640	*37040	33770	*31550	23710	27660	17530	*19930	13370	35.18
1.5 m (5 ft)	kg		*24760	22820	*18540	14560	*15320	10320	12290	7720	*9420	6070	10.66
	lb		*51590	50310	*40880	32100	*33770	22750	27100	17010	*20770	13380	34.82
Boden-niveau	kg		*25340	22320	*19390	14110	*15870	10020			*9990	6380	10.29
	lb		*55860	49210	*42740	31100	*34980	22090			*22230	14070	33.62
-1.5 m (-5 ft)	kg	*24530	*24530	*24590	22260	*19270	13950	*15750	9910		*10880	7120	9.63
	lb	*54080	*54080	*54220	49070	*42480	30750	*34720	21840		*23960	15700	31.47
-3.0 m (-10 ft)	kg	*29690	*29690	*22760	22480	*18120	14040	*14610	10020		*11430	8670	8.59
	lb	*65460	*65460	*50180	49560	*39940	30960	*32200	22100		*25200	19120	28.07
-4.5 m (-15 ft)	kg			*19480	*19490	*15400	14460				*10840	*10840	7.5
	lb			*42950	*42950	*33860	31880				*23900	*23900	24.5











1. Die Hublast richtet sich nach der Definition in SAE J1097 und ISO 10567.
2. Die Hublast der Serie ROBEX darf auf festem, ebenem Untergrund maximal 75 % der Kippplast der Maschine bzw. 87 % der gesamten hydraulischen Hubkraft betragen.

3. Der Lasthaken befindet sich an der Rückseite des Tieflöffels.
4. (\*) gibt die Lastbegrenzung durch die hydraulische Hubkraft an.











 Lastradius Frontauslage  Lastradius Seitenauslage bzw. 360 Grad

## HX520 L











7,06 m (23' 2") Ausleger; 2,40 m (7' 10") Löffelstiel; 0,92 m<sup>3</sup> Löffel (nach SAE gehäuft); 600 mm (24") 3-Step-Bodenplatten

Lasthöhe m (ft)	Lastradius										Max. Reichweite		
	3.0 m (10 ft)		4.5 m (15 ft)		6.0 m (20 ft)		7.5 m (25 ft)		9.0 m (30 ft)		Volumen	Reichweite	
												m (ft)	
7.5 m (25 ft)	kg						*11960	11760			*10860	7810	9.66
	lb						*26360	25920			*23940	17210	31.56
6.0 m (20 ft)	kg				*13590	*13590	*12590	11430			10460	6730	10.35
	lb				*29970	*29970	*27750	25200			23050	14840	33.8
4.5 m (15 ft)	kg				*15800	15620	*13470	10950	*12580	8060	9650	6150	10.74
	lb				*34820	34430	*30150	24130	*27740	17770	21280	13550	35.07
3.0 m (10 ft)	kg				*17920	14690	*14820	10450	12380	7810	9320	5880	10.87
	lb				*38510	32390	*32680	23030	27290	17210	20540	12970	35.52
1.5 m (5 ft)	kg				*19270	14070	*15690	10050	12140	7590	9380	5900	10.76
	lb				*42480	31010	*34590	22150	26760	16730	20670	13000	35.16
Boden-niveau	kg				*19640	13780	15940	9820			9870	6210	10.4
	lb				*43300	30370	35140	21640			21760	13700	33.97
-1.5 m (-5 ft)	kg		*23730	22120	*19170	13740	*15770	9760			10980	6740	9.75
	lb		*52320	48760	*42270	30290	*34760	21530			24210	15300	31.85
-3.0 m (-10 ft)	kg	*26500	*26500	*21830	*21830	*17840	13910	*14540	9930		*11140	8420	8.74
	lb	*58420	*58420	*48130	*48130	*39330	30680	*32060	21900		*24560	18560	28.54
-4.5 m (-15 ft)	kg			*18680	*18680	*15140	14380				*10560	10260	7.8
	lb			*41180	*41180	*33380	31710				*23280	22620	25.47

7,06 m (23' 2") Ausleger; 2,90 m (9' 6") Löffelstiel; 0,92 m<sup>3</sup> Löffel (nach SAE gehäuft); 600 mm (24") 3-Step-Bodenplatten

Lasthöhe m (ft)	Lastradius										Max. Reichweite		
	3.0 m (10 ft)		4.5 m (15 ft)		6.0 m (20 ft)		7.5 m (25 ft)		9.0 m (30 ft)		Volumen	Reichweite	
												m (ft)	
7.5 m (25 ft)	kg						*11360	*11360			*9210	7190	10.11
	lb						*25050	*25050			*20310	15860	33.03
6.0 m (20 ft)	kg						*12120	11520			*9220	6250	10.76
	lb						*26730	25400			*20340	13770	35.15
4.5 m (15 ft)	kg		*19010	*19010	*15110	*15110	*13300	11010	*12330	8060	9050	5720	11.13
	lb		*41900	*41900	*33310	*33310	*29320	24270	*27180	17770	19940	12600	36.37
3.0 m (10 ft)	kg		*23620	23090	*17420	14840	*14570	10470	12350	7770	8730	5470	11.26
	lb		*52060	50900	*38400	32710	*32120	23090	27230	17130	19250	12600	36.8
1.5 m (5 ft)	kg		*21570	*21570	*19080	14200	*15610	10020	12070	7510	8770	5460	11.16
	lb		*47560	*47560	*42070	31080	*34410	22090	26600	16560	19320	12040	36.45
Boden-niveau	kg		*25090	21760	*19800	13690	15860	9730	11880	7340	9180	5720	10.81
	lb		*55310	47970	*43660	30190	34960	21440	26180	16170	20230	12610	35.32
-1.5 m (-5 ft)	kg	*20350	*20350	*24810	21780	*19640	13570	15730	9610		10110	6330	10.19
	lb	*44860	*44560	*54690	48020	*43300	29910	34670	21180		22280	13950	33.3
-3.0 m (-10 ft)	kg	*28610	*28610	*23130	22020	*18630	13670	*15310	9690		*11360	7540	9.23
	lb	*63060	*63060	*50990	48550	*41080	30140	*33750	21360		*25040	16620	30.17
-4.5 m (-15 ft)	kg			*20370	*20370	*16510	14020				*10730	10170	7.79
	lb			*44710	*44910	*36390	30910				*23650	22430	25.43

7,06 m (23' 2") Ausleger; 3,38 m (11' 1") Löffelstiel; 0,92 m<sup>3</sup> Löffel (nach SAE gehäuft); 600 mm (24") 3-Step-Bodenplatten

















Lasthöhe m (ft)	Lastradius										Max. Reichweite		
	3.0 m (10 ft)		4.5 m (15 ft)		6.0 m (20 ft)		7.5 m (25 ft)		9.0 m (30 ft)		Volumen	Reichweite	
												m (ft)	
6.0 m (20 ft)	kg						*11640	*11640	*11410	8380	*7750	5820	11.18
	lb						*25650	*25650	*25160	18480	*17080	12840	36.53
4.5 m (15 ft)	kg		*17410	*17410	*14350	*14350	*12860	11130	*12030	8110	*7860	5340	11.54
	lb		*38390	*38390	*31640	*31640	*28360	24540	*26530	17890	*17330	11780	37.7
3.0 m (10 ft)	kg		*22210	*22210	*16770	15090	*14210	10580	12390	7800	*8060	5120	11.67
	lb		*48960	*48960	*36960	33280	*31330	23320	27320	17200	*17760	11280	38.11
1.5 m (5 ft)	kg		*25070	22400	*18660	14280	*15370	10100	12080	7520	8240	5100	11.57
	lb		*55270	49380	*41150	31490	*33880	22260	26630	16570	18160	11250	37.78
Boden-niveau	kg		*25800	21880	*19670	13790	15990	9760	11848	7310	8580	5320	11.23
	lb		*56880	48230	*43370	30400	35040	21510	26120	16110	18930	11730	36.69
-1.5 m (-5 ft)	kg	*19680	*19680	*25300	21780	*19800	13580	15700	9580	11750	7210	5830	10.64
	lb	*43390	*43390	*55780	48010	*43640	29940	34620	21130	25890	15900	12860	34.77
-3.0 m (-10 ft)	kg	*25950	*25950	*23920	21930	*19080	13600	15710	9590		*10510	6840	9.74
	lb	*57200	*57200	*52700	48450	*42070	29990	346230	21140		*23180	15080	31.82
-4.5 m (-15 ft)	kg	*27870	*27870	*21540	*21540	*17390	13850				*10990	8910	8.39
	lb	*61430	*61430	*47480	*47480	*38330	30530				*24230	19640	27.41

- Die Hublast richtet sich nach der Definition in SAE J1097 und ISO 10567.
- Die Hublast der Serie ROBEX darf auf festem, ebenem Untergrund maximal 75 % der Kipplast der Maschine bzw. 87 % der gesamten hydraulischen Hubkraft betragen.
- Der Lasthaken befindet sich an der Rückseite des Tieflöffels.
- (\* ) gibt die Lastbegrenzung durch die hydraulische Hubkraft an.















 Lastradius Frontauslage  Lastradius Seitenauslage bzw. 360 Grad

## HX520 L

7,06 m (23' 2") Ausleger; 4,0 m (13' 1") Löffelstiel; 0,92 m<sup>3</sup> Löffel (nach SAE gehäuft); 600 mm (24") 3-Step-Bodenplatten

Lasthöhe m (ft)	Lastradius										Max. Reichweite							
	1.5 m (5 ft)		3.0 m (10 ft)		4.5 m (15 ft)		6.0 m (20 ft)		7.5 m (25 ft)		9.0 m (30 ft)		10.5 m (35 ft)		Volumen	Reichweite		
																	m (ft)	
7.5 m (25 ft)	kg											*10410	8730			*7170	6000	11.19
	lb											*22950	19250			*15800	13240	36.54
6.0 m (20 ft)	kg											*10810	8540			*7190	5300	11.77
	lb											*23840	18830			*15850	11680	38.45
4.5 m (15 ft)	kg								*12150	11350		*11540	8240	*9510	6140	*7280	4880	12.11
	lb								*26790	25030		*25430	18170	*20960	13550	*16050	10770	39.55
3.0 m (10 ft)	kg			*20300	*20300	*15800	15460	*13620	10760	*12390	7900	9570	5960	*7450	4680	*7450	4680	12.23
	lb			*44750	*44750	*34820	34070	*30040	23730	*27310	17410	21110	13140	*16430	10310	*16430	10310	39.94
1.5 m (5 ft)	kg			*24060	22850	*18020	14520	*14970	10220	12150	7570	9380	5780	7590	4650	7590	4650	12.13
	lb			*53050	50390	*39730	32020	*33000	22530	26780	16690	20670	12730	16720	10260	16720	10260	39.63
Boden- niveau	kg		*14190	*14190	*25720	21980	*19430	13890	*15930	9805	11860	7310	9230	5640	7860	4820	7860	11.82
	lb		*31290	*31290	*56710	48450	*42840	30620	*35120	21620	26150	16120	20340	12430	17340	10630	17340	38.6
-1.5 m (-5 ft)	kg	*14900	*14900	*18380	*18380	*25860	21670	*19950	13560	15680	9560	11690	7160		8490	5240	8490	11.26
	lb	*32850	*32850	*40520	*40520	*57000	47780	*43950	29900	34570	21070	25770	15770		18730	11550	18730	36.78
-3.0 m (-10 ft)	kg	*19020	*19020	*23290	*23290	*24940	21700	*19620	13480	15600	9480	16670	7140		7460	6020	7460	10.42
	lb	*41940	*41940	*51340	*51340	*54990	47830	*43250	29720	34390	20910	25720	15730		20850	13280	20850	34.05
-4.5 m (-15 ft)	kg			*29320	*29320	*23030	21980	*18390	13630	*15130	9600				10910	7550	10910	9.2
	lb			*64640	*64640	*50750	48470	*40550	30040	*33350	21160				24050	16650	24050	30.05
-6.0 m (-20 ft)	kg					*19800	*19800	*15870	14040						10660	9810	10660	7.93
	lb					*43650	*43550	*35000	30950						23500	21620	23500	25.91

9,0 m (29' 6") Ausleger; 6,0 m (19' 8") Löffelstiel; 0,92 m<sup>3</sup> Löffel (nach SAE gehäuft); 600 mm (24") 3-Step-Bodenplatten

Lasthöhe m (ft)	Lastradius										Max. Reichweite							
	3.0m (9.8ft)		5.0m (16.3ft)		7.0m (22.9ft)		9.0m (29.4ft)		11.0m (35.9ft)		13.0m (42.5ft)		Volumen	Reichweite				
															m (ft)			
8.0 m (26 ft)	kg											*6240	4340			*5120	3370	14.83
	lb											*13760	9560			*11280	7430	48.46
6.0 m (20 ft)	kg								*9373	6090		6910	4180			5060	2900	15.44
	lb								*20670	13410		15230	9204			11160	6390	50.43
4.0 m (13 ft)	kg							*11050	8260			9120	5650			4720	2620	15.74
	lb							*24370	18200			20100	12460			10410	5770	51.4
2.0 m (7 ft)	kg			*21520	18830	*15430	11260	12150	7480	8930	5200	6370	3670			4580	2490	15.75
	lb			*47440	41510	*34020	24830	26790	16490	19030	11470	14040	8090			10100	5480	51.44
Boden- niveau	kg	*9910	*9910	*18740	16960	17170	10170	11440	6830	8206	4800	6120	3430			4640	2500	15.47
	lb	*21840	*21840	*41310	37400	37850	22420	25210	15060	18090	10590	13490	7570			10220	5510	50.54
-2.0 m (-7 ft)	kg	*12430	*12430	*18870	16250	16450	9540	10950	6390	7990	4520	5950	3270			4910	2670	14.9
	lb	*27400	*27400	*41310	35830	36270	21030	24140	14090	17410	9960	13110	7210			10830	5880	48.66
-4.0 m (-13 ft)	kg	*15220	*15220	*21280	16130	16170	9290	10710	6170	7740	4370					5500	3060	13.97
	lb	*33560	*33560	*46910	35570	35650	20480	23620	13610	17070	9640					12120	6740	45.64
-6.0 m (-20 ft)	kg	*18350	*18350	*24410	16380	16220	9340	10710	6180	7780	4410					6630	3820	12.62
	lb	*40460	*40460	*53810	36110	35760	20580	23620	13610	17150	9720					14620	8420	41.22
-8.0 m (-26 ft)	kg	*21930	*21930	*21960	16950	16590	9660	10990	6430							9060	5450	10.63
	lb	*48340	*48340	*48410	37370	36570	21290	24230	14170							19970	12020	34.72
-10.0 m (-33 ft)	kg			*17820	*17820	*13830	10380									*10570	7950	8.72
	lb			*39280	*39280	*30490	22880									*23290	17520	28.48

- Die Hublast richtet sich nach der Definition in SAE J1097 und ISO 10567.
- Die Hublast der Serie ROBEX darf auf festem, ebenem Untergrund maximal 75 % der Kippplast der Maschine bzw. 87 % der gesamten hydraulischen Hubkraft betragen.

- Der Lasthaken befindet sich an der Rückseite des Tieflöffels.
- (\*) gibt die Lastbegrenzung durch die hydraulische Hubkraft an.

ENGINE	STD	OPT
Scania-Motor DC13 084A	●	
<b>HYDRAULIKSYSTEM</b>		
<b>IPC (Intelligent Power Control)</b>		
3 Leistungsstufen, 2 Arbeitsarten, Benutzermodus	●	
Variable Leistungssteuerung	●	
Pumpenfördermengenregelung	●	
Volumenstromregelung für Anbaugerät-Betriebsart		●
Automatischer Motorleerlauf	●	
Automatische Motorabschaltung		●
<b>KABINE UND INNENRAUM</b>		
<b>Kabine nach ISO-Norm</b>		
Obenrunder Frontscheibenwischer	●	
Radio/USB-Player	●	
Mobiltelefon-Freisprecheinrichtung mit USB	●	
12-Volt-Steckdose (Wandler 24 VDC auf 12 VDC)	●	
Elektrisches Signalhorn	●	
Allwetter-Stahlkabine mit 360°-Rundumsicht	●	
Sicherheitsglasscheiben	●	
Frontscheibe einschiebbar	●	
Seitenscheibe (links) als Schiebefenster	●	
Abschließbare Tür	●	
Warmhalte- und Kühlbox	●	
Aufbewahrungsfach und Aschenbecher	●	
Kabinendachabdeckung transparent	●	
Sonnenblende	●	
Tür- und Kabinenschlösser, ein Schlüssel	●	
Mechanisch gefederter, beheizter Sitz	●	
Vorsteuerdruckunterstützter Joystick	●	
Konsole höhenverstellbar	●	
<b>Automatische Klimaregelung</b>		
Klimaanlage und Heizung	●	
Scheibenheizung	●	
Starthilfe (Ansaugluftvorwärmung) bei kalten Temperaturen	●	
<b>Zentrale Überwachung</b>		
8-Zoll-LCD	●	
Motordrehzahl oder Tageszähler/Beschleunigung	●	
Motorkühlmittel-Temperaturanzeige	●	
Max. Leistung	●	
Kriechgang/Schnellgang	●	
Automatischer Leerlauf	●	
Überlast	●	
Motor überprüfen	●	
Luftfilter verstopft	●	
Anzeigen	●	
ÖKO-Anzeigen	●	
Kraftstoffstandanzeige	●	
Anzeige für die Hydrauliköltemperatur	●	
Kraftstoffvorwärmer	●	
Warnungen	●	
Kommunikationsfehler	●	
Batterie niedrig	●	
Uhr	●	
Kabinenscheinwerfer	●	
Regenschutz für Kabinenfrontfenster	●	
Kabinendachabdeckung in Stahl		●
<b>Sitz</b>		
Einstellbarer Fahrersitz mit Luftfederung und Heizung		●
<b>Kabinen-FOPS/FOG (ISO/DIN 10262) Stufe 2</b>		
FOPS (Schutzzeineinrichtung gegen herabfallende Gegenstände) - ISO 3449 Stufe 2	●	
FOG (Schutzaufbau gegen herabfallende Gegenstände)		●
<b>Kabinen-ROPS (ISO 12117-2)</b>		
ROPS (Überrollschutz)	●	

SICHERHEIT	STD	OPT
Batterie Hauptschalter	●	
Heckkamera	●	
Kameragestützte virtuelle Draufsicht incl. Bewegobjektüberwachung (AAVM + MOD)		●
Vier Arbeitsscheinwerfer	●	
Fahralarm	●	
Arbeitsscheinwerfer hinten	●	
Rundumleuchte		●
Automatische Schwenkbremse	●	
Auslegerhaltesystem	●	
Stielhaltesystem	●	
Sicherheitsventil für Auslegerzylinder mit Überlastwarneinrichtung	●	
Sicherheitsventil für Löffelstielzylinder		●
Drei Außenrückspiegel	●	
<b>SONSTIGES</b>		
<b>Ausleger</b>		
6,55 m; 21' 6"		●
7,06 m; 23' 2"	●	
9,00 m; 29' 6"		●
<b>Löffelstiel</b>		
2,4 m; 7' 10"		●
2,9 m; 9' 6"		●
3,38 m; 11' 1"	●	
4,0 m; 13' 1"		●
6,0 m; 19' 8"		●
Herausnehmbares Kühlerstaubgitter	●	
Herausnehmbarer Vorratsbehälter	●	
Kraftstoffvorfilter mit Kraftstoffvorwärmer	●	
Regenschutzkappe	●	
Vorreiniger		●
Selbstdiagnosesystem	●	
Hi-mate (Maschinenmanagementsystem)	●	
Batterien (2 x 12 V x 200 Ah)	●	
Kraftstoffbetankungspumpe (50 l/min)		●
Einfach wirkende Verrohrung (Hydraulikhammer usw.)		●
Doppelt wirkende Verrohrung (Zweischalengreifer usw.)	●	
Verrohrung für drehende Anbaugeräte		●
Verrohrung für hydraulische Schnellwechslers		●
Schnellwechsler		●
Auslegerschwimmsteuerung		●
Druckspeicher beim Senken der Arbeitseinrichtung	●	
Bedienschema-Umschaltventil (2 Muster)		●
Werkzeugsatz		●
<b>UNTERWAGEN</b>		
Unterbodenschutz Unterwagen (extra)		●
Unterbodenschutz Unterwagen (normal)	●	
<b>Bodenplatten</b>		
3-Steg-Bodenplatten (600 mm; 24")	●	
3-Steg-Bodenplatten (700 mm; 28")		●
3-Steg-Bodenplatten (750 mm; 30")		●
3-Steg-Bodenplatten (800 mm; 32")		●
2-Steg-Bodenplatten (600 mm; 24")		●
2-Steg-Bodenplatten (700 mm; 28")		●
Bodenplatten für hohe Beanspruchung (600 mm; 24")		●
Bodenplatten für hohe Beanspruchung (700 mm; 28")		●
Laufrollenschutz	●	
Laufrollenschutz "High Walker"		●

STD = Standard  
OPT = Optional

- \* Standard- und Wahlausstattung können je nach Modell abweichen. Weitere Informationen erhalten Sie von Ihrem Hyundai-Händler. Die Maschinenausstattung kann von internationalen Normen abhängig sein.
- \* Auf den Fotos können Anbauten und optionale Geräte abgebildet sein, die in Ihrer Region nicht erhältlich sind.
- \* Änderungen der Materialien und technischen Daten vorbehalten.
- \* Alle Maße in angloamerikanischen Maßeinheiten sind auf das nächste volle Maß (Pound oder Zoll) gerundet.